















Fiyat
Listesi
2018

6	Slim LED Panel Ofis Armatürleri	
10	Backlight Ofis Armatürleri	
12	Sıva Üstü Backlight Ofis Armatürleri	
13	Inovatif Ofis Armatürleri	
14	Sıva Altı & Üstü Backlight Ofis Armatürleri	
15	Sıva Altı Mimari Ofis Armatürleri	
16	Sıva Altı & Üstü Ofis Armatürleri	
17	Steril Ortam ve Hastane Armatürleri	
18	Lineer Armatürler	
20	Mimari Sarkıt & Sıva Üstü Armatürler	
21	Dekoratif Sarkıt Armatürler	
22	Sıva Altı Backlight LED Downlight Armatürler	
24	Sıva Altı Slim LED Downlight Armatürler	

26	Sıva Altı & Üstü Slim LED Downlight Armatürler	
27	LED Ray Spotlar	
28	LED Spot Armatürler	
29	LED Aplikler	
30	LED Tavan Armatürleri	
32	IP66 Tavan Armatürleri	
34	Sensörler	
36	Sensörlü Armatürler	
37	Bant Armatürler	
40	Etanj Armatürler	
43	Acil Aydınlatma Armatürleri	
44	Acil Yönlendirme Armatürleri	
46	Okul Armatürleri	

47	Yüksek Tavan Armatürleri			
49	Yüksek Tavan ve Atölye Armatürleri			
50	Benzinlik Armatürleri			
51	Ex-Proof Armatürler			
52	LED Projektörler			
56	Projektörler			
57	Wallwasherlar			
58	LEDli Yol Aydınlatma Armatürleri			
60	Yol Aydınlatma Armatürleri			
62	LEDli Park Bahçe Aydınlatma Armatürleri			
66	LEDli Park Bahçe Aydınlatma Armatürleri			
68	Takım Park Bahçe Armatürleri			
71	Çimen Armatürleri			

72	Aplik & Set Üstü Armatürler																																																																																																																																																																																																																																		
73	Duvar Gömme ve Yer Gömme Armatürleri																																																																																																																																																																																																																																		
74	Lambalar																																																																																																																																																																																																																																		
78	LED Şerit ve Sürücüler																																																																																																																																																																																																																																		
79	Neon LED ve Zincir Modül																																																																																																																																																																																																																																		
80	LED Bar ve Sürücüler																																																																																																																																																																																																																																		
81	Balast ve Kitler																																																																																																																																																																																																																																		
82	Komponentler																																																																																																																																																																																																																																		
83	Panolar																																																																																																																																																																																																																																		
84	Anahtar ve Prizler																																																																																																																																																																																																																																		
92	Grup Prizler																																																																																																																																																																																																																																		
95	Fırsat Ürünleri																																																																																																																																																																																																																																		
102	Kod İndeks	<table border="1"> <thead> <tr> <th>Kod No</th> <th>Sayfa</th> <th>Sıra</th> <th>Kod No</th> <th>Sayfa</th> <th>Sıra</th> <th>Kod No</th> <th>Sayfa</th> <th>Sıra</th> <th>Kod No</th> <th>Sayfa</th> <th>Sıra</th> <th>Kod No</th> <th>Sayfa</th> <th>Sıra</th> </tr> </thead> <tbody> <tr> <td>3035 451</td> <td>59</td> <td>6</td> <td>4201 817</td> <td>35</td> <td>9</td> <td>5014 4582</td> <td>13</td> <td>3</td> <td>5021 1532</td> <td>37</td> <td>6</td> <td>5118 4611</td> <td>18</td> <td>3</td> </tr> <tr> <td>3110 102</td> <td>84</td> <td>6</td> <td>4201 821</td> <td>35</td> <td>11</td> <td>5014 4711</td> <td>12</td> <td>2</td> <td>5021 1542</td> <td>37</td> <td>6</td> <td>5118 4621</td> <td>18</td> <td>3</td> </tr> <tr> <td>3110 103</td> <td>84</td> <td>6</td> <td>4201 822</td> <td>35</td> <td>11</td> <td>5014 4712</td> <td>12</td> <td>2</td> <td>5021 1552</td> <td>37</td> <td>6</td> <td>5211 1010</td> <td>59</td> <td>2</td> </tr> <tr> <td>3110 106</td> <td>84</td> <td>6</td> <td>4301 642</td> <td>81</td> <td>3</td> <td>5014 4731</td> <td>12</td> <td>2</td> <td>5021 1562</td> <td>37</td> <td>6</td> <td>5211 1013</td> <td>59</td> <td>2</td> </tr> <tr> <td>3110 112</td> <td>84</td> <td>6</td> <td>4301 652</td> <td>81</td> <td>3</td> <td>5014 4732</td> <td>12</td> <td>2</td> <td>5021 1572</td> <td>37</td> <td>6</td> <td>5211 1014</td> <td>59</td> <td>2</td> </tr> <tr> <td>3110 113</td> <td>84</td> <td>6</td> <td>4301 662</td> <td>81</td> <td>3</td> <td>5014 4741</td> <td>12</td> <td>2</td> <td>5021 1582</td> <td>37</td> <td>6</td> <td>5211 1110</td> <td>58</td> <td>5</td> </tr> <tr> <td>3110 120</td> <td>84</td> <td>5</td> <td>4301 672</td> <td>81</td> <td>3</td> <td>5014 4742</td> <td>12</td> <td>2</td> <td>5021 8220</td> <td>36</td> <td>6</td> <td>5211 1115</td> <td>58</td> <td>5</td> </tr> <tr> <td></td> <td></td> <td></td> <td></td> <td></td> <td></td> <td></td> <td></td> <td></td> <td></td> <td></td> <td></td> <td>5413 2011</td> <td>32</td> <td>1</td> </tr> <tr> <td></td> <td></td> <td></td> <td></td> <td></td> <td></td> <td></td> <td></td> <td></td> <td></td> <td></td> <td></td> <td>5413 2014</td> <td>32</td> <td>3</td> </tr> <tr> <td></td> <td></td> <td></td> <td></td> <td></td> <td></td> <td></td> <td></td> <td></td> <td></td> <td></td> <td></td> <td>5413 2060</td> <td>99</td> <td>9</td> </tr> <tr> <td></td> <td></td> <td></td> <td></td> <td></td> <td></td> <td></td> <td></td> <td></td> <td></td> <td></td> <td></td> <td>5413 2113</td> <td>32</td> <td>2</td> </tr> <tr> <td></td> <td></td> <td></td> <td></td> <td></td> <td></td> <td></td> <td></td> <td></td> <td></td> <td></td> <td></td> <td>5413 2114</td> <td>32</td> <td>4</td> </tr> <tr> <td></td> <td></td> <td></td> <td></td> <td></td> <td></td> <td></td> <td></td> <td></td> <td></td> <td></td> <td></td> <td>5511 2391</td> <td>83</td> <td>4</td> </tr> <tr> <td></td> <td></td> <td></td> <td></td> <td></td> <td></td> <td></td> <td></td> <td></td> <td></td> <td></td> <td></td> <td>5511 2401</td> <td>83</td> <td>4</td> </tr> </tbody> </table>	Kod No	Sayfa	Sıra	Kod No	Sayfa	Sıra	Kod No	Sayfa	Sıra	Kod No	Sayfa	Sıra	Kod No	Sayfa	Sıra	3035 451	59	6	4201 817	35	9	5014 4582	13	3	5021 1532	37	6	5118 4611	18	3	3110 102	84	6	4201 821	35	11	5014 4711	12	2	5021 1542	37	6	5118 4621	18	3	3110 103	84	6	4201 822	35	11	5014 4712	12	2	5021 1552	37	6	5211 1010	59	2	3110 106	84	6	4301 642	81	3	5014 4731	12	2	5021 1562	37	6	5211 1013	59	2	3110 112	84	6	4301 652	81	3	5014 4732	12	2	5021 1572	37	6	5211 1014	59	2	3110 113	84	6	4301 662	81	3	5014 4741	12	2	5021 1582	37	6	5211 1110	58	5	3110 120	84	5	4301 672	81	3	5014 4742	12	2	5021 8220	36	6	5211 1115	58	5													5413 2011	32	1													5413 2014	32	3													5413 2060	99	9													5413 2113	32	2													5413 2114	32	4													5511 2391	83	4													5511 2401	83	4
Kod No	Sayfa	Sıra	Kod No	Sayfa	Sıra	Kod No	Sayfa	Sıra	Kod No	Sayfa	Sıra	Kod No	Sayfa	Sıra																																																																																																																																																																																																																					
3035 451	59	6	4201 817	35	9	5014 4582	13	3	5021 1532	37	6	5118 4611	18	3																																																																																																																																																																																																																					
3110 102	84	6	4201 821	35	11	5014 4711	12	2	5021 1542	37	6	5118 4621	18	3																																																																																																																																																																																																																					
3110 103	84	6	4201 822	35	11	5014 4712	12	2	5021 1552	37	6	5211 1010	59	2																																																																																																																																																																																																																					
3110 106	84	6	4301 642	81	3	5014 4731	12	2	5021 1562	37	6	5211 1013	59	2																																																																																																																																																																																																																					
3110 112	84	6	4301 652	81	3	5014 4732	12	2	5021 1572	37	6	5211 1014	59	2																																																																																																																																																																																																																					
3110 113	84	6	4301 662	81	3	5014 4741	12	2	5021 1582	37	6	5211 1110	58	5																																																																																																																																																																																																																					
3110 120	84	5	4301 672	81	3	5014 4742	12	2	5021 8220	36	6	5211 1115	58	5																																																																																																																																																																																																																					
												5413 2011	32	1																																																																																																																																																																																																																					
												5413 2014	32	3																																																																																																																																																																																																																					
												5413 2060	99	9																																																																																																																																																																																																																					
												5413 2113	32	2																																																																																																																																																																																																																					
												5413 2114	32	4																																																																																																																																																																																																																					
												5511 2391	83	4																																																																																																																																																																																																																					
												5511 2401	83	4																																																																																																																																																																																																																					

Mioled Serisi Edgelight Ofis Armatürleri

4x18W Parabolik'e Eşdeğer Işık!

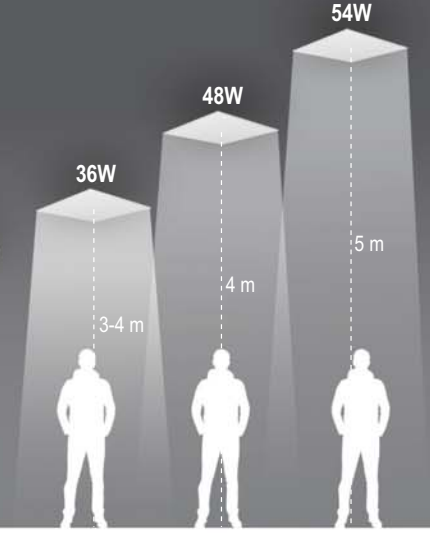

Mioled 60x60 Sıva Altı 36W



IP40

Kod No	Özellikler	Koli Adedi	Fiyat
106071	36W 60X60 3000K	5	39,50 \$
106072	36W 60X60 4000K	5	39,50 \$
106073	36W 60X60 6500K	5	39,50 \$

Mioled 60x60 Clip-in 36W



IP40

Kod No	Özellikler	Koli Adedi	Fiyat
106089	36W 60X60 3000K Clip-in	5	41,75 \$
106090	36W 60X60 4000K Clip-in	5	41,75 \$
106093	36W 60X60 6500K Clip-in	5	41,75 \$

Mioled 60x60 Sıva Altı 48W

Yeni
Ürün



IP40

Kod No	Özellikler	Koli Adedi	Fiyat
107966	48W 60X60 4000K	5	52,00 \$
107967	48W 60X60 6500K	5	52,00 \$

Mioled 60x60 Sıva Altı 54W

Yeni
Ürün



IP40

Kod No	Özellikler	Koli Adedi	Fiyat
107968	54W 60X60 4000K	5	60,30 \$
107969	54W 60X60 6500K	5	60,30 \$

Opsiyonlar



Kod No	Özellikler	Koli Adedi	Fiyat
313118	Panel Acil Ayd. Kiti (Tüm Paneller ile uyumlu)	1	29,00 \$
	Triac Dim	1	28,50 \$
	1-10V Dim	1	56,50 \$
	DALI Dim	1	56,50 \$

Panel Aksesuarları



Kod No	Özellikler	Koli Adedi	Fiyat
313524	Askı Aksesuarı (4 Adet)	1	5,55 \$
313526	Alçıpan Aksesuar Takımı(4 adet)	1	3,00 \$

Mioled 30x30 Sıva Altı 20W



IP40

12mm

Kod No	Özellikler	Koli Adedi	Fiyat
108089	20W 30X30 3000K	10	20,80 \$
108023	20W 30X30 4000K	10	20,80 \$
108024	20W 30X30 6500K	10	20,80 \$

Mioled 30x30 Clip-in 20W



IP40

12mm

Kod No	Özellikler	Koli Adedi	Fiyat
108104	20W 30x30 3000K Clip-in	10	22,95 \$
108029	20W 30x30 4000K Clip-in	10	22,95 \$
108030	20W 30x30 6500K Clip-in	10	22,95 \$

Mioled 30x60 Sıva Altı 30W



IP 40

12mm

Kod No	Özellikler	Koli Adedi	Fiyat
108087	30W 30X60 3000K	5	36,40 \$
108025	30W 30X60 4000K	5	36,40 \$
108026	30W 30X60 6500K	5	36,40 \$

Mioled 30x120 Sıva Altı 40W



IP 40

12mm

Kod No	Özellikler	Koli Adedi	Fiyat
108088	40W 30X120 3000K	5	52,00 \$
108027	40W 30X120 4000K	5	52,00 \$
108028	40W 30X120 6500K	5	52,00 \$

Mono Slim Panel Çerçevesi Sıva Üstü Çerçeve Aparatı



Yeni
Ürün



60mm

Kod No	Özellikler	Koli Adedi	Fiyat
315382	60X60 Slim Panel S.Ü. Çerçeve Aparatı	5	13,30 \$
315898	30X30 Slim Panel S.Ü. Çerçeve Aparatı	5	8,30 \$

Duo Slim Panel Çerçevesi Sıva Üstü Çerçeve Aparatı



60mm

Kod No	Özellikler	Koli Adedi	Fiyat
311266	60X60 Slim Panel S.Ü. Çerçeve Aparatı	5	11,30 \$
311267	30X30 Slim Panel S.Ü. Çerçeve Aparatı	5	7,10 \$
311268	30X60 Slim Panel S.Ü. Çerçeve Aparatı	5	8,20 \$
311269	30X120 Slim Panel S.Ü. Çerçeve Aparatı	5	11,30 \$

Mioled Performans

Sıva Altı 36 W



110 lm/W

Yüksek Tavanlar için

Mioled Performans, 3.50- 5.50 metre arasındaki tavan yüksekliğine sahip yapılarda gereken aydınlık düzeyini veren ideal bir çözümdür.

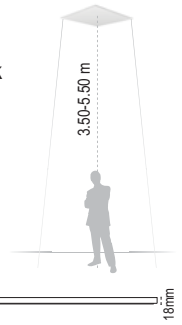

IP 40

Kod No	Özellikler	Koli Adedi	Fiyat
108114	36W 60X60 4000K 110 lm/W	5	52,00 \$
108115	36W 60X60 6500K 110 lm/W	5	52,00 \$

Mioled Konfor

Sıva Altı 36W



UGR<19

Yüksek Göz Konforu için

Mioled Konfor, özel difüzör ve LED çipleri sayesinde kamaşmayı engelleyerek işinize odaklanmanızı sağlar.

Yeni Ürün

IP 40

Kod No	Özellikler	Koli Adedi	Fiyat
108116	36W 60X60 4000K URG<19	5	50,00 \$
108117	36W 60X60 6500K URG<19	5	50,00 \$

Mioled Plus

Sıva Altı 36W



ENEC Belgeli

Mioled Plus, Avrupa menşeli komponente sahiptir.

Yeni Ürün



IP 40

Kod No	Özellikler	Koli Adedi	Fiyat
108419	36W 60X60 3000K ENEC	5	50,20 \$
106060	36W 60X60 4000K ENEC	5	50,20 \$
108418	36W 60X60 6500K ENEC	5	50,20 \$

Calisto

Sıva Altı 36W

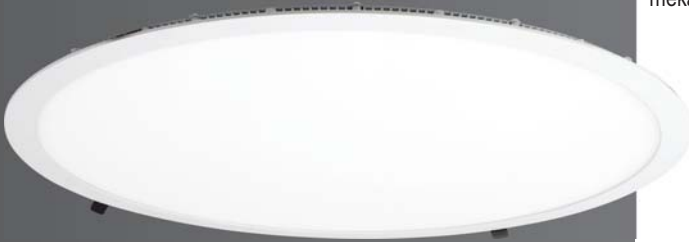

Oval Çizgiler

Panel serisini oval hatlar ile buluşturan Calisto mekanlara estetik bir görünüm katar.

Yeni Ürün

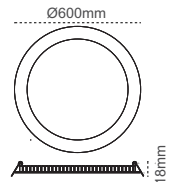

IP 40

Kod No	Özellikler	□ (mm)	Koli Adedi	Fiyat
108252	36W Ø60cm 6500K	590mm	5	79,00 \$

Mio-Tech Slim LED Panel Ofis Armatürleri



Mioled IP65

Sıva Altı 40W



IP65 Toz ve Su Almaz!

Nemli ve steril alanlara IP65 Mioled

Yeni
Ürün

IP 65

Kod No	Özellikler	Koli Adedi	Fiyat
108152	40W 60X60 6500K IP65	5	179,00 \$

18mm

Mioled Aura

Sıva Altı 45W



Mioled Aura ile Kontrol Sizde!

Mioled Aura kontrol kumandasıyla dim edilir.
Renk sıcaklığı ayarlanır.

Yeni
Ürün



Renk
Değiştirir

Dim
Edilir

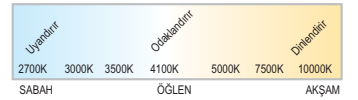

IP 40

Kod No	Özellikler	Koli Adedi	Fiyat
108161	45W 60X60 Aura	5	159,00 \$

18mm

Mioled Sun-up

Sıva Altı 40W



Mioled Sun-up ile Daha Fazla Tasarruf

Dahili gün ışığı sensörü sayesinde aydınlatma şiddetini ayarlayarak maksimum verimlilik sağlar.

Yeni
Ürün

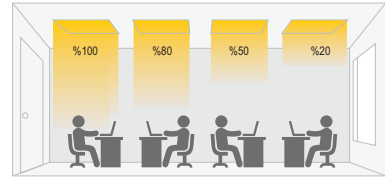

IP 40

Kod No	Özellikler	Koli Adedi	Fiyat
108162	40-20W 60X60 6500K	5	147,00 \$

18mm

Mioled Speaker

Sıva Altı 40W



Mioled Speaker ile...

Günlük aydınlatma düzeninizi hareketlendirin.

Yeni
Ürün



Dahili
Hoparlör

Bluetooth

IP 40

Kod No	Özellikler	Koli Adedi	Fiyat
108153	40W 60X60 6500K Speaker	5	229,00 \$

18mm

Isoled



Kredi Yurtlar Kurumu ile hastane şartnamelerine uygun



Özel projeler için özel çözüm



Clip-in uygulaması ve acil aydınlatma ünite opsiyonlu



100 lm/W'ı aşan etkinlik faktörü



Avrupa driver



1-10V dim ve DALI seçenekleri

Isoled Plus

Sıva Altı



IP 40

Performans* Serisi: +115 lm/W

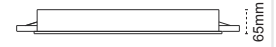

Kod No	Özellikler	Koli Adedi	Fiyat	Kod No	Özellikler	Koli Adedi	Fiyat
108417	28W 60X60 S.A. 6500K TSE-ENEC	5	58,25 \$	108420	28W 60X60 S.A. 6500K Performans* TSE-ENEC	5	62,70 \$
105659	33W 60X60 S.A. 6500K TSE-ENEC	5	60,50 \$	108471	33W 60X60 S.A. 6500K Performans* TSE-ENEC	5	65,00 \$
105679	42W 60X60 S.A. 6500K TSE-ENEC	5	71,00 \$	108470	42W 60X60 S.A. 6500K Performans* TSE-ENEC	5	75,50 \$

Isoled Plus

Sıva Üstü



IP 40

Performans* Serisi: +115 lm/W

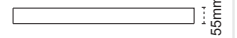

Kod No	Özellikler	Koli Adedi	Fiyat	Kod No	Özellikler	Koli Adedi	Fiyat
108423	28W 60X60 S.Ü. 6500K TSE-ENEC	5	62,30 \$	108425	28W 60X60 S.Ü. 6500K Performans* TSE-ENEC	5	66,80 \$
108303	33W 60X60 S.Ü. 6500K TSE-ENEC	5	64,70 \$	108480	33W 60X60 S.Ü. 6500K Performans* TSE-ENEC	5	69,20 \$
108478	42W 60X60 S.Ü. 6500K TSE-ENEC	5	75,20 \$	108479	42W 60X60 S.Ü. 6500K Performans* TSE-ENEC	5	79,70 \$

Opsiyonlar



IP 40

Kod No	Özellikler	Koli Adedi	Fiyat
313118	Isoled Acil Aydınlatma Kiti	1	29,00 \$
313527	Isoled Alçıpan Yayı (4adet)	1	3,00 \$

Opsiyonlar



IP 40

Özellikler	Koli Adedi	Fiyat Farkı
Triac Dim	1	28,50 \$
1-10V Dim	1	56,50 \$
Dali Dim	1	56,50 \$

Isolated 60x60
Sıva Altı 42/33W



IP 40 



Kod No	Özellikler	Koli Adedi	Fiyat
105655	33W 60X60 S.A. 6500K	5	49,90 \$
106176	42W 60X60 S.A. 6500K	5	60,30 \$

Isolated 60x60
Clip-in 42/33W



IP 40 



Kod No	Özellikler	Koli Adedi	Fiyat
105665	33W 60X60 Clip-in 6500K	5	52,10 \$
106211	42W 60X60 Clip-in 6500K	5	62,60 \$

Isolated 30x30
Sıva Altı 12W



IP 40 



Kod No	Özellikler	Koli Adedi	Fiyat
106162	12W 30X30 S.A. 6500K	5	34,90 \$

Isolated 30x30
Clip-in 12W



IP 40 



Kod No	Özellikler	Koli Adedi	Fiyat
106217	12W 30X30 S.A. Clip-in 6500K	5	37,10 \$
100141	2XE27 30x30 Clip-in	5	15,75 \$

Isolated 30x60
Sıva Altı 17W



IP 40 



Kod No	Özellikler	Koli Adedi	Fiyat
106167	17W 30X60 S.A. 6500K	4	42,75 \$

Clipled 30x30
Clip-in 20W

Yeni Ürün 





IP 40 



Kod No	Özellikler	Koli Adedi	Fiyat
108085	20W 30X30 Clip-in 6500K	20	27,00 \$

Isolated 30x120
Sıva Altı 33W



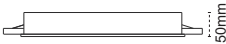

IP 40 



Kod No	Özellikler	Koli Adedi	Fiyat
106185	33W 30X120 S.A. 6500K	4	69,25 \$

Isolated 60x120
Sıva Altı 84W



IP 40 

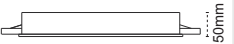

Kod No	Özellikler	Koli Adedi	Fiyat
106191	84W 60X120 S.A. 6500K	2	170,00 \$

Pelsan Sıva Üstü Backlight Ofis Armatürleri

Isoled 60x60
Sıva Üstü 33/42W

Yeni Ürün



IP 20

Kod No	Özellikler	Koli Adedi	Fiyat
108462	33W 60x60 S.Ü. 6500K	5	54,00 \$
108511	42W 60x60 S.Ü. 6500K	5	64,50 \$

Dekaled 60x60
Sıva Üstü 33/42W



IP 20

Kod No	Özellikler	Koli Adedi	Fiyat
105694	33W 60x60 S.Ü. 6500K	5	60,20 \$
105702	42W 60x60 S.Ü. 6500K	5	78,50 \$

Isoled 30x30
Sıva Üstü 12W

Yeni Ürün



IP 20

Kod No	Özellikler	Koli Adedi	Fiyat
108384	12W 30x30 S.Ü. 6500K	4	39,00 \$

Dekaled 30x30
Sıva Üstü 12W



IP 20

Kod No	Özellikler	Koli Adedi	Fiyat
105710	12W 30x30 S.Ü. 6500K	4	55,00 \$

Isoled 30x120
Sıva Üstü 33/42W

Yeni Ürün



IP 20

Kod No	Özellikler	Koli Adedi	Fiyat
108482	33W 30x120 S.Ü. 6500K	4	73,90 \$
108483	42W 30x120 S.Ü. 6500K	4	84,40 \$

Dekaled 30x120
Sıva Üstü 33/42W



IP 20

Kod No	Özellikler	Koli Adedi	Fiyat
105707	33W 30x120 S.Ü. 6500K	4	88,00 \$
108510	42W 30x120 S.Ü. 6500K	4	100,00 \$

Isoled 30x60
Sıva Üstü 17W

Yeni Ürün



IP 20

Kod No	Özellikler	Koli Adedi	Fiyat
108481	17W 30x60 S.Ü. 6500K	4	46,90 \$

Dekaled 30x60
Sıva Üstü 17W



IP 20

Kod No	Özellikler	Koli Adedi	Fiyat
105708	17W 30x60 S.Ü. 6500K	4	63,50 \$

Opsiyon Farkları

Kod No	Özellikler	Koli Adedi	Fiyat
313118	Sıva Üstü Backlight Panel Acil Ayd. Kiti	1	29,00 \$

Divaled

Işığın Soft Hali!



Direkt ve Endirekt Aydınlatma

Divaled opal difüzörden yayılan direkt ışığı ve kamaşma kontrollü özel reflektöründen yayılan endirekt ışığı ile soft bir aydınlatma sağlar.



Özel Kamaşma Kontrolü

Bankalar, ofisler, konferans salonları, hastaneler ve lobilerde kamaşmayı engelleyerek göz konforunu artırır.



Estetik Görünüm

Divaled'in minimal çizgileri ve dekoratif tasarımı mekanlarınıza estetik görünüm katar.

Divaled

Sıva Altı 42W

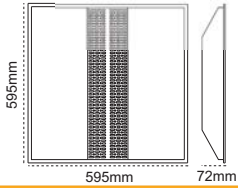

Kolay ve Hızlı Montaj

Fonksiyonel tasarımı sayesinde elektriksel bağlantısı kolay ve hızlı yapılır.



IP 20

Kod No	Özellikler	Koli Adedi	Fiyat
108408	42W 60x60 S.A. 6500K	4	92,50 \$

Isoled Ambiyans

Sıva Altı



Isoled Ambiyans, özel difüzörü sayesinde farklı açılardan farklı ışık hareleri sunar.



Kamaşma kontrollü özel difüzör



100 lm/W'ı aşan verimlilik



DALI, 1-10V dim ve acil aydınlatma kit opsiyonu



Clip-in opsiyonu



Avrupa driver opsiyonu

IP 40

Kod No	Özellikler	Koli Adedi	Fiyat
105631	12W 30X30 S.A. 6500K Ambiyans	5	81,00 \$
105635	17W 30X60 S.A. 6500K Ambiyans	4	98,00 \$
105637	33W 60X60 S.A. 6500K Ambiyans	5	104,00 \$
105641	42W 60X60 S.A. 6500K Ambiyans	5	150,00 \$
105646	42W 30X120 S.A. 6500K Ambiyans	4	218,00 \$

65mm

Pelsan Sıva Altı ve Sıva Üstü Backlight Ofis Armatürleri

Fioled Sıva Altı / Clip-in



Fioled2 60x60 47mm



Fioled3 60x60 47mm

Kod No	Özellikler	Koli Adedi	Fiyat	Kod No	Özellikler	Koli Adedi	Fiyat
106852	33W 60X60 S.A. 6500K	4	63,40 \$	106860	33W 60X60 S.A. 6500K	4	63,40 \$
106856	33W 60X60 Clip-in 6500K	4	65,40 \$	106869	33W 60X60 Clip-in 6500K	4	65,40 \$

Fioled Sıva Üstü



Fioled2 60x60 66mm



Fioled3 60x60 66mm

Kod No	Özellikler	Koli Adedi	Fiyat	Kod No	Özellikler	Koli Adedi	Fiyat
106854	33W 60X60 S.Ü. 6500K	4	69,10 \$	106865	33W 60X60 S.Ü. 6500K	4	69,10 \$

Seoled Sıva Altı / Clip-in



Seoled1 30x30 67mm



Seoled2 60x60 67mm



Seoled3 60x60 67mm

Kod No	Özellikler	Koli Adedi	Fiyat	Kod No	Özellikler	Koli Adedi	Fiyat	Kod No	Özellikler	Koli Adedi	Fiyat
106737	8W 30X30 S.A. 6500K	4	51,85 \$	106713	30W 60X60 S.A. 6500K	4	67,40 \$	106725	30W 60X60 S.A. 6500K	4	67,40 \$
106745	8W 30X30 Clip-in 6500K	4	53,85 \$	106719	30W 60X60 Clip-in 6500K	4	69,40 \$	106731	30W 60X60 Clip-in 6500K	4	69,40 \$
106697	33W 60X60 S.A. 6500K	4	67,40 \$								
106707	33W 60X60 Clip-in. 6500K	4	69,40 \$								

Seoled Sıva Üstü



Seoled1 60x60 66mm



Seoled2 60x60 66mm



Seoled3 60x60 66mm

Kod No	Özellikler	Koli Adedi	Fiyat	Kod No	Özellikler	Koli Adedi	Fiyat	Kod No	Özellikler	Koli Adedi	Fiyat
106741	8W 30X30 S.Ü. 6500K	4	55,55 \$	106716	30W 60X60 S.Ü. 6500K	4	71,10 \$	106728	30W 60X60 S.Ü. 4000/6500K	4	71,10 \$
106757	17W 30X60 S.Ü. 6500K	4	65,55 \$								
106703	33W 60X60 S.Ü. 6500K	4	71,10 \$								
106773	30W 30X120 S.Ü. 6500K	4	95,10 \$								

Opsiyon Farkları

Kod No	Özellikler	Koli Adedi	Fiyat
313118	Seoled-Fioled Acil Ayd. Kiti	1	29,00\$
313127	Alçıpan yayı (4 adet)	1	3,00\$

Halley LED 60x60 Sıva Altı

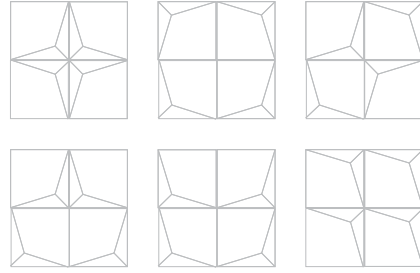

4'lü kullanım önerisi

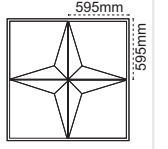

IP 40

Kod No Özellikler
108307 33W 60x60 S.A. 6500K

Koli Adedi Fiyat
4 115,00 \$

Galaxy LED 60x60 Sıva Altı

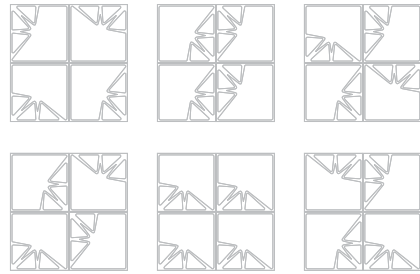

4'lü kullanım önerisi

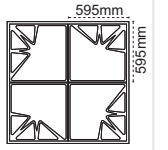

IP 40

Kod No Özellikler
106249 33W 60x60 S.A. 6500K

Koli Adedi Fiyat
4 115,00 \$

Cion LED 60x60 Sıva Altı

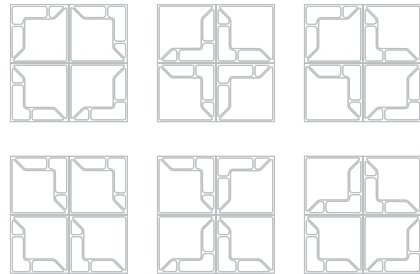

4'lü kullanım önerisi

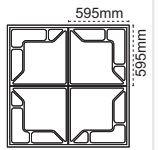

IP 40

Kod No Özellikler
108512 33W 60x60 S.A. 6500K

Koli Adedi Fiyat
4 105,00 \$

Gupur LED 60x60 Sıva Altı

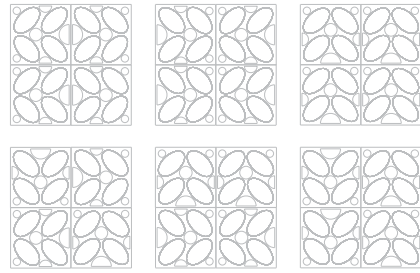

4'lü kullanım önerisi

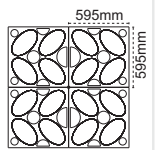

IP 40

Kod No Özellikler
106233 33W 60x60 S.A. 6500K

Koli Adedi Fiyat
4 105,00 \$

Pelsan Sıva Altı ve Sıva Üstü Ofis Armatürleri

Isolamp T5 Sıva Altı



Kod No	Özellikler	Koli Adedi	Fiyat
100891	2X14W T5 Elk. Bal. S.A.	6	39,20 \$
100896	3X14W T5 Elk. Bal. S.A.	6	45,10 \$
100908	4X14W T5 Elk. Bal. S.A.	6	45,10 \$
100963	2X28W T5 Elk. Bal. S.A.	4	45,10 \$
101701	4X14W T5 Elk. Clip-in	6	47,20 \$

Dekolamp T5 Sıva Üstü



Kod No	Özellikler	Koli Adedi	Fiyat
101467	2X14W T5 Elk. Bal. S.Ü.	6	41,30 \$
101480	4X14W T5 Elk. Bal. S.Ü.	6	47,20 \$
101498	2X28W T5 Elk. Bal. S.Ü.	4	47,20 \$

7 Lamel Çift Parabolik Sıva Altı



Kod No	Özellikler	Koli Adedi	Fiyat
101148	2X18W TLD Elk. Bal. S.A.	4	38,80 \$
101176	4X18W TLD Elk. Bal. S.A.	4	43,00 \$
101217	2X36W TLD Elk. Bal. S.A.	4	43,00 \$

Dekolamp Sıva Üstü



Kod No	Özellikler	Koli Adedi	Fiyat
101843	2X18W TLD Elk. Bal. S.Ü.	6	40,90 \$
101881	4X18W TLD Elk. Bal. S.Ü.	6	45,20 \$
101922	2X36W TLD Elk. Bal. S.Ü.	4	45,20 \$

Prizmatik Lensli-Opal Lensli Sıva Altı



Kod No	Özellikler	Lens	Koli Adedi	Fiyat
100566	2X18W TLD Elk. Bal. S.A.	Prizmatik	4	37,70 \$
100583	4X18W TLD Elk. Bal. S.A.	Prizmatik	4	42,00 \$
100602	2X36W TLD Elk. Bal. S.A.	Prizmatik	4	42,00 \$
101586	2X18W TLD Elk. Bal. S.A.	Opal	4	42,00 \$
101597	4X18W TLD Elk. Bal. S.A.	Opal	4	46,20 \$
101612	2X36W TLD Elk. Bal. S.A.	Opal	4	46,20 \$

Dekolamp Prizmatik-Opal Lensli Sıva Üstü



Kod No	Özellikler	Lens	Koli Adedi	Fiyat
101045	2X18W TLD Elk. Bal. S.Ü.	Prizmatik	6	39,90 \$
101057	4X18W TLD Elk. Bal. S.Ü.	Prizmatik	6	44,10 \$
101076	2X36W TLD Elk. Bal. S.Ü.	Prizmatik	4	44,10 \$
101970	2X18W TLD Elk. Bal. S.Ü.	Opal	6	44,10 \$
101981	4X18W TLD Elk. Bal. S.Ü.	Opal	6	48,30 \$
101994	2X36W TLD Elk. Bal. S.Ü.	Opal	4	48,30 \$

Endirekt 1 Perfore Sıva Altı



Kod No	Özellikler	Koli Adedi	Fiyat
108378	3X24W T5 Elk. Bal. S.A.	3	78,40 \$
102121	2X24W T5 Elk. Bal. S.A.	3	67,80 \$

Dekolamp Endirekt Perfore Sıva Üstü



Kod No	Özellikler	Koli Adedi	Fiyat
102297	2X24W T5 Elk. Bal. S.Ü.	3	72,10 \$
102300	3X24W T5 Elk. Bal. S.Ü.	3	81,60 \$

IP65 Mioled
Sıva Altı 60x60 40W

Yeni Ürün



IP65

18mm

Kod No	Özellikler	Koli Adedi	Fiyat
108152	40W 60x60 S.A. 6500K IP65	5	179,00 \$

Negatoskop



IP 40

678mm 103mm 500mm

Kod No	Özellikler	Koli Adedi	Fiyat
106101	42W LED 60X60 S.Ü.6500K	1	161,10 \$
106103	84W LED 60X120 S.Ü.6500K	1	222,60 \$

IP65 LED Steril
Sıva Altı Temperli Kumlu Camlı



IP 65

100mm

Kod No	Özellikler	Koli Adedi	Fiyat
106198	33W 60x60 S.A. 6500K IP65 Steril	4	153,70 \$

IP65 LED Steril
Sıva Üstü Temperli Kumlu Camlı



IP 65

75mm

Kod No	Özellikler	Koli Adedi	Fiyat
106057	33W 60x60 S.Ü. 6500K IP65 Steril	4	161,70 \$

IP65 Steril
Sıva Altı Temperli Kumlu Camlı



IP 65

100mm

Kod No	Özellikler	Koli Adedi	Fiyat
100743	2X18W TLD Elk. Bal. S.A.	4	77,40 \$
100752	4X18W TLD Elk. Bal. S.A.	3	81,60 \$
100765	2X36W TLD Elk. Bal. S.A.	3	96,50 \$
100025	2X14W T5 Elk. Bal. S.A.	4	79,50 \$
100017	4X14W T5 Elk. Bal. S.A.	3	94,30 \$
100013	2X28W T5 Elk. Bal. S.A.	3	97,50 \$

IP65 Steril
Sıva Üstü Temperli Kumlu Camlı



IP 65

75mm

Kod No	Özellikler	Koli Adedi	Fiyat
100706	2X18W TLD Elk. Bal. S.Ü.	4	82,70 \$
100714	4X18W TLD Elk. Bal. S.Ü.	4	97,50 \$
100722	2X36W TLD Elk. Bal. S.Ü.	410	1,80 \$
100736	2X14W T5 Elk. Bal. S.Ü.	4	84,80 \$
101387	4X14W T5 Elk. Bal. S.Ü.	4	99,60 \$
101344	2X28W T5 Elk. Bal. S.Ü.	4	102,80 \$

IP65 Steril
Sıva Altı Temperli Camlı



IP 65

100mm

Kod No	Özellikler	Koli Adedi	Fiyat
101364	2X18W TLD Elk. Bal. S.A.	4	83,70 \$
101324	4X18W TLD Elk. Bal. S.A.	3	101,80 \$
101373	2X36W TLD Elk. Bal. S.A.	3	106,00 \$

IP65 Steril
Sıva Üstü Temperli Camlı



IP 65

75mm

Kod No	Özellikler	Koli Adedi	Fiyat
100993	2X18W TLD Elk. Bal. S.Ü.	4	89,00 \$
101003	4X18W TLD Elk. Bal. S.Ü.	4	107,10 \$
101016	2X36W TLD Elk. Bal. S.Ü.	4	111,30 \$

Recta

**3 Metreye Kadar
Kesintisiz Gövde
Seçeneği**

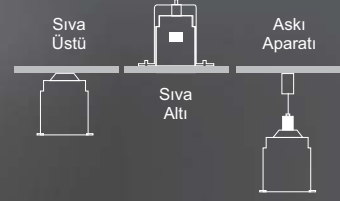

- Renk Opsiyonları**
- RAL 9005 - Siyah
 - RAL 9006 - Gri
 - RAL 9016 - Beyaz

- Opsiyonlar**
- 1-10V Dim
 - DALI Dim
 - 3 saate kadar acil aydınlatma

- Avrupa LED Çip ve Driver

**Recta Lux LED
Sıva Üstü 57mm**



IP 40

Kod No	Özellikler	a x b x c	Koli Adedi	Fiyat
106256	17W 6500K	600X58X76 mm	1	65,90 \$
106263	25W 6500K	900X58X76 mm	1	98,60 \$
106276	36W 6500K	1200X58X76 mm	1	109,70 \$
106294	45W 6500K	1500X58X76 mm	1	142,40 \$
304906	Recta Askı Aparatı 100cm		1	11,60 \$

**Recta Lux LED
Sıva Üstü 85mm**



IP 40

Kod No	Özellikler	a x b x c	Koli Adedi	Fiyat
106331	17W 6500K	600X85X76	1	64,90 \$
106335	25W 6500K	900X85X76	1	99,70 \$
106343	36W 6500K	1200X85X76	1	110,80 \$
108158	45W 6500K	1500X85X76	1	143,50 \$
304915	Recta Askı Aparatı 150cm		1	14,80 \$

**Recta Lux LED
Sıva Altı 57mm**



IP 40

Kod No	Özellikler	a x b x c	□ (mm)	Koli Adedi	Fiyat
106317	25W 6500K	916X76X76	902x60	1	98,60 \$
108536	36W 6500K	1236X76X76	1222x60	1	109,70 \$
106328	45W 6500K	1526X76X76	1512x60	1	141,40 \$

**Recta Lux LED
Sıva Altı 85mm**

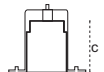

IP 40

Kod no	Özellikler	a x b x c	□ (mm)	Koli Adedi	Fiyat
106360	25W 6500K	916X108X76	902x87	1	99,70 \$
107875	36W 6500K	1236X108X76	1222x87	1	110,80 \$
108537	45W 6500K	1526X108X76	1512x87	1	143,50 \$

Lineer Aydınlatmada İnce Çizgiler

- 4000K/6500K renk sıcaklığı seçenekleri mevcuttur.
- Avrupa menşeli LED sürücü

Recta LED Slim
Sarkıt 36mm

Yeni Ürün



● 1m askı aparatı dahildir.

IP 40

62 mm
36 mm

Kod No	Özellikler	Koli Adedi	Fiyat
102956	25W 6500K 1200 mm	12	69,50 \$

Recta LED Slim
Sarkıt 36mm

Yeni Ürün



● 1m askı aparatı dahildir.

IP 40

62 mm
36 mm

Kod No	Özellikler	Koli Adedi	Fiyat
108078	25W 6500K 1200 mm	12	69,50 \$

Recta LED
Sıva Üstü 57mm

Yeni Ürün



76 mm
57 mm

Kod No	Özellikler	Koli Adedi	Fiyat
102957	20W 6500K 600 mm	1	48,40 \$
102960	20W 6500K 1200 mm	1	60,20 \$
102966	36W 6500K 1200 mm	1	63,80 \$
108538	45W 6500K 1500 mm	1	80,75 \$

Recta LED
Sıva Altı 57mm

Yeni Ürün



76 mm
57 mm

Kod No	Özellikler	Koli Adedi	Fiyat
102971	20W 6500K 600 mm	1	48,40 \$
102974	20W 6500K 1200 mm	1	60,20 \$
102980	36W 6500K 1200 mm	1	63,80 \$
108539	45W 6500K 1200 mm	1	80,75 \$

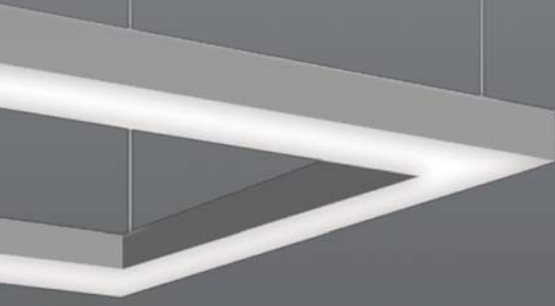

Quad LED

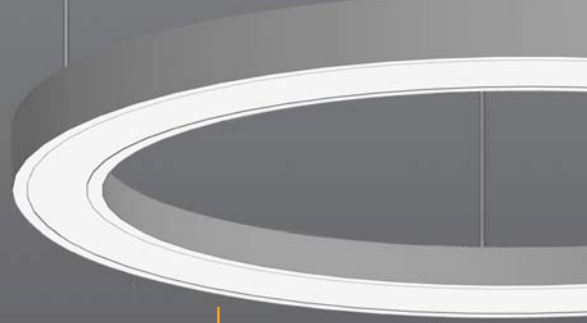

Circa LED



Polaris LED

Opsiyonları

- DALI
- 1-10V Dim
- 3 saate kadar acil aydınlatma

Renk Opsiyonları

- RAL 9005 - Siyah
- RAL 9006 - Gri
- RAL 9016 - Beyaz

● Askı aparatı dahildir.

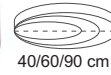
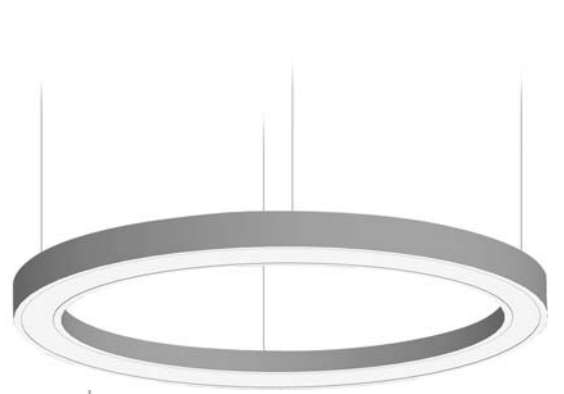
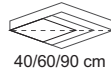
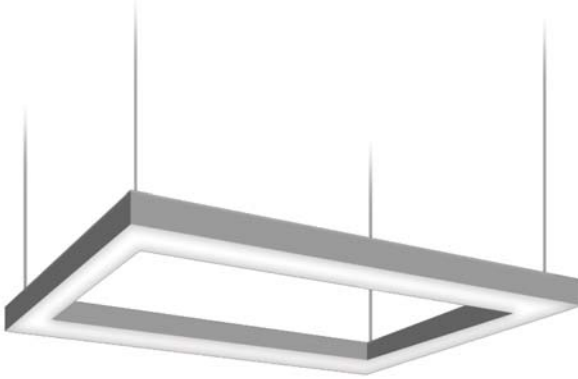

Quad LED

Kod No	Özellikler	Koli Adedi	Fiyat
108513	20W 4000K	1	210,00 \$
106298	75W 4000K	1	285,00 \$
106307	100W 4000K	1	350,00 \$

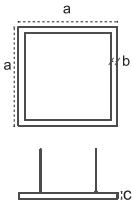

axbcm
20W : 400x57x100
75W : 600x57x100
100W : 900x57x100

Polaris LED

Kod No	Özellikler	Koli Adedi	Fiyat
105807	40W 4000K	1	235,00 \$
105814	60W 4000K	1	298,00 \$
105818	70W 4000K	1	393,00 \$

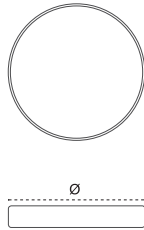

Øxhmm
40W : 400x75
60W : 600x75
70W : 900x75

Circa LED

Kod No	Özellikler	Koli Adedi	Fiyat
105796	45W 4000K	1	298,00 \$
108201	65W 4000K	1	353,00 \$
108202	100W 4000K	1	436,00 \$

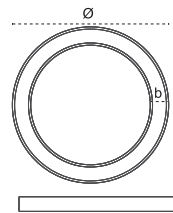

Øxbcm
45W : 600x74x100
65W : 900x74x100
100W : 1200x74x100



Volga



Beraberinde kullanılabilecek LED lambalar için sayfa 75'i inceleyebilirsiniz.

Volga Alüminyum Gövde



IP 20 ☺

Kod No	Özellikler	Koli Adedi	Fiyat
106642	50W LED 6500K Beyaz	6	79,50 \$
106639	50W LED 6500K Gümüş	6	79,50 \$
106654	50W LED 6500K Altın	6	79,50 \$
104236	E27 Beyaz	6	39,90 \$
104235	E27 Gümüş	6	39,90 \$
104240	E27 Altın	6	39,90 \$

Rodos Alüminyum Gövde



IP 20 ☺

Kod No	Özellikler	Koli Adedi	Fiyat
103776	E27 Siyah	4	29,90 \$
103775	E27 Beyaz	4	29,90 \$
103778	E27 Bakır Oksit	4	29,90 \$
103777	E27 Altın Oksit	4	29,90 \$

Avsha Alüminyum Gövde



IP 20 ☺

Kod No	Özellikler	Koli Adedi	Fiyat
103773	E27 Siyah	4	29,90 \$
103774	E27 Gri	4	29,90 \$

Pico Alüminyum Gövde



IP 20 ☺

Kod No	Özellikler	Koli Adedi	Fiyat
103782	E27 Siyah	4	29,90 \$
103781	E27 Beyaz	4	29,90 \$

Simi Alüminyum Gövde



IP 20 ☺

Kod No	Özellikler	Koli Adedi	Fiyat
103779	E27 Gri	4	29,90 \$

Tuna / Sana



IP 20 ☺

Kod No	Özellikler	Koli Adedi	Fiyat
104278	Tuna E27 Q33	4	23,70 \$
104284	Sana E27 Q44	4	39,00 \$



Ofis, İş Yeri, Mağaza ve Binanıza Uygun Bir Tira Armatür Mutlaka Vardır!



- 15-20-23,5 cm gövde çapı seçeneği
- Her gövde seçeneği için 3 çeşit güç opsiyonu
- İstenilen renk sıcaklığı uygulama opsiyonu
- Mat siyah ve beyaz çerçeve renk seçeneği
- Avrupa LED çip ve driver
- 3 saate kadar acil aydınlatma ünite opsiyonu
- DALI Dim opsiyonu

Tira Ø İçten Camlı

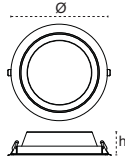

Øxhmm
7W : 148x56,5
10W : 148x56,5
15W : 197x56,5
20W : 197x56,5
25W : 233x56,5
35W : 233x56,5

Kod No	Özellikler	Ø (mm)	Koli Adedi	Fiyat
108054	5W S.A. 6500K	132	20	29,60 \$
107045	7W S.A. 6500K	132	20	30,60 \$
108502	10W S.A. 6500K	132	20	31,70 \$
108060	10W S.A. 6500K	185	15	38,50 \$
108503	15W S.A. 6500K	185	15	40,60 \$
107047	20W S.A. 6500K	185	15	42,70 \$
108068	20W S.A. 6500K	220	10	54,70 \$
108514	25W S.A. 6500K	220	10	61,00 \$
108515	35W S.A. 6500K	220	10	67,30 \$

Tira ı İçten Camlı

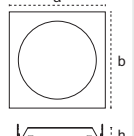

axb x h mm
7W : 148x148x56,5
10W : 148x148x56,5
15W : 197x197x56,5
20W : 197x197x56,5
25W : 233x233x56,5
35W : 233x233x56,5

Kod No	Özellikler	(mm)	Koli Adedi	Fiyat
107051	5W S.A. 6500K	132	20	29,60 \$
107053	7W S.A. 6500K	132	20	30,60 \$
107055	10W S.A. 6500K	132	20	31,70 \$
107057	10W S.A. 6500K	185	15	38,50 \$
107059	15W S.A. 6500K	185	15	40,60 \$
107061	20W S.A. 6500K	185	15	42,70 \$
107063	20W S.A. 6500K	220	10	54,70 \$
107065	25W S.A. 6500K	220	10	61,00 \$
107067	35W S.A. 6500K	220	10	67,30 \$

Tira Ø Hemyüz

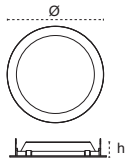

Øxhmm
10W : 190x50
15W : 190x50
20W : 240x50
25W : 240x50
35W : 240x50

Kod No	Özellikler	Ø (mm)	Koli Adedi	Fiyat
107087	10W S.A. 6500K	185	15	36,40 \$
107089	15W S.A. 6500K	185	15	38,50 \$
107091	20W S.A. 6500K	185	15	40,60 \$
107093	20W S.A. 6500K	225	10	52,60 \$
107096	25W S.A. 6500K	225	10	58,90 \$
107098	35W S.A. 6500K	225	10	65,20 \$

Tira IP54

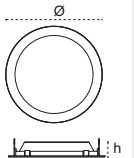

Øxhmm
7W : 148x56,5
10W : 148x56,5
15W : 197x56,5
20W : 197x56,5
25W : 240x56,5
35W : 240x56,5

Kod No	Özellikler	Ø (mm)	Koli Adedi	Fiyat
107070	7W IP54 S.A. 6500K	132	20	37,40 \$
107073	10W IP54 S.A. 6500K	132	20	38,50 \$
107076	15W IP54 S.A. 6500K	185	15	54,20 \$
107079	20W IP54 S.A. 6500K	185	15	56,30 \$
107082	25W IP54 S.A. 6500K	220	10	74,60 \$
107085	35W IP54 S.A. 6500K	220	10	80,90 \$

Opsiyon Farkları

Kod No	Özellikler	Koli Adedi	Fiyat
313118	Tira Acil Aydınlatma Kiti	1	30,40 \$

Tıra 150mm Ø İçten Camlı

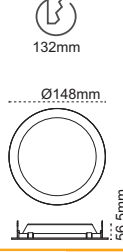

IP 40 ☺

Kod No	Özellikler	Koli Adedi	Fiyat
106929	5W S.A. 6500K	20	27,50 \$
106935	7W S.A. 6500K	20	28,50 \$
106938	10W S.A. 6500K	20	29,60 \$

Tıra 150mm Ø İçten Camlı

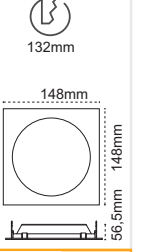

IP 40 ☺

Kod No	Özellikler	Koli Adedi	Fiyat
106992	5W S.A. 6500K	20	27,50 \$
106995	7W S.A. 6500K	20	28,50 \$
106998	10W S.A. 6500K	20	29,60 \$

Tıra 200mm Ø İçten Camlı

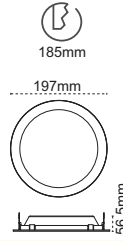

IP 40 ☺

Kod No	Özellikler	Koli Adedi	Fiyat
106944	10W S.A. 6500K	15	36,40 \$
106951	15W S.A. 6500K	15	38,50 \$
106962	20W S.A. 6500K	15	40,60 \$

Tıra 200mm Ø İçten Camlı

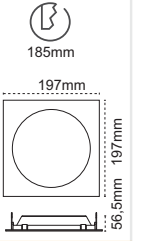

IP 40 ☺

Kod No	Özellikler	Koli Adedi	Fiyat
107004	10W S.A. 6500K	15	36,40 \$
107007	15W S.A. 6500K	15	38,50 \$
107013	20W S.A. 6500K	15	40,60 \$

Tıra 230mm Ø İçten Camlı

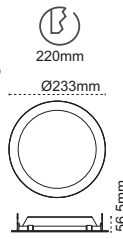

IP 40 ☺

Kod No	Özellikler	Koli Adedi	Fiyat
106970	20W S.A. 6500K	10	52,60 \$
106978	25W S.A. 6500K	10	58,90 \$
106986	35W S.A. 6500K	10	65,20 \$

Tıra 230mm Ø İçten Camlı

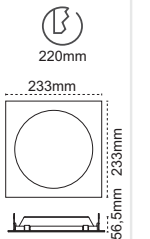

IP 40 ☺

Kod No	Özellikler	Koli Adedi	Fiyat
107019	20W S.A. 6500K	10	52,60 \$
107022	25W S.A. 6500K	10	58,90 \$
107026	35W S.A. 6500K	10	65,20 \$

Opsiyon Farkları

Kod No	Özellikler	Koli Adedi	Fiyat
313118	Tıra Acil Aydınlatma Kiti	1	30,40 \$

Rita



Entegre sürücü ile kolay montaj sağlar.



İçten difüzörlü tasarımı sayesinde kamaşmayı önler.



Backlight teknolojisi ile yüksek lümen sunar.



Rita serisi backlight armatürler beyan edilen güç ve lümeni verir.

Rita 6W Sıva Altı

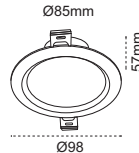

Yeni Ürün

IP 40

Kod No	Özellikler	Ø mm	Koli Adedi	Fiyat
108266	6W S.A. 4000K	85	100	10,40 \$
108256	6W S.A. 6500K	85	100	10,40 \$

Rita 9W Sıva Altı

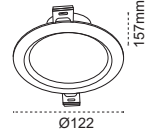

Yeni Ürün

IP 40

Kod No	Özellikler	Ø mm	Koli Adedi	Fiyat
108268	9W S.A. 4000K	100	100	13,00 \$
108267	9W S.A. 6500K	100	100	13,00 \$

Rita 12W Sıva Altı

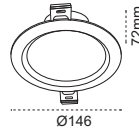

Yeni Ürün

IP 40

Kod No	Özellikler	Ø mm	Koli Adedi	Fiyat
108270	12W S.A. 4000K	125	50	18,10 \$
108269	12W S.A. 6500K	125	50	18,10 \$

Rita 18W Sıva Altı

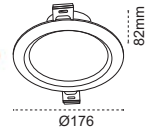

Yeni Ürün

IP 40

Kod No	Özellikler	Ø mm	Koli Adedi	Fiyat
108272	18W S.A. 4000K	155	30	22,60 \$
108271	18W S.A. 6500K	155	30	22,60 \$

Sirma Çift Renkli Sıva Altı

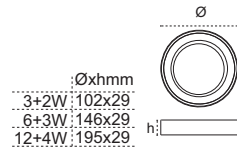

IP 40

Kod No	Özellikler	Ø mm	Koli Adedi	Fiyat
204207	3+2W S.A. 6500K + Mavi	85	60	7,70 \$
204211	6+3W S.A. 6500K + Mavi	120	40	9,50 \$
204183	12+4W S.A. 6500K + Mavi	165	20	11,50 \$

Sirma Kare Sıva Altı



Yeni Ürün

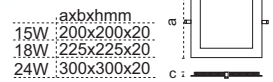

IP 40

Kod No	Özellikler	Ø mm	Koli Adedi	Fiyat
108325	15W S.A. 6500K	170x170	30	9,85 \$
108328	18W S.A. 6500K	200x200	30	10,35 \$
108327	24W S.A. 6500K	275x275	20	23,55 \$

Sırma



**7 Farklı Güç, 7 Farklı Boyut
Şimdi Çok Özel Fiyatlara**

Üstelik TSE Belgeli!

- 1W=1W çeker
- Pelsan Slim LED Downlightlar beyan ettiği güç ve lümeni verir.
- Alüminyum gövde, alüminyum çerçeve
- 3 saate kadar acil aydınlatma ünite opsiyonu

Sırma 3W

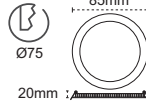

IP 40

Kod No	Özellikler	Koli Adedi	Fiyat
107891	3W 3000K	60	3,35 \$
107892	3W 4000K	60	3,35 \$
107893	3W 6500K	60	3,35 \$

Sırma 6W

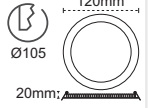

IP 40

Kod No	Özellikler	Koli Adedi	Fiyat
107918	6W 3000K	30	4,80 \$
107919	6W 4000K	30	4,80 \$
107920	6W 6500K	30	4,80 \$

Sırma 9W

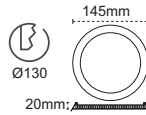

IP 40

Kod No	Özellikler	Koli Adedi	Fiyat
107921	9W 3000K	30	5,95 \$
107922	9W 4000K	30	5,95 \$
107923	9W 6500K	30	5,95 \$

Sırma 12W

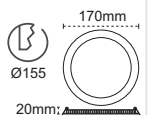

IP 40

Kod No	Özellikler	Koli Adedi	Fiyat
107924	12W 3000K	30	8,25 \$
106427	12W 4000K	30	8,25 \$
106428	12W 6500K	30	8,25 \$

Sırma 15W

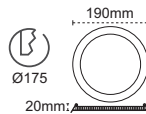

IP 40

Kod No	Özellikler	Koli Adedi	Fiyat
106431	15W 3000K	30	9,85 \$
106430	15W 4000K	30	9,85 \$
106432	15W 6500K	30	9,85 \$

Sırma 18W

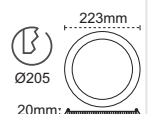

IP 40

Kod No	Özellikler	Koli Adedi	Fiyat
107925	18W 3000K	30	10,35 \$
106433	18W 4000K	30	10,35 \$
106434	18W 6500K	30	10,35 \$

Sırma 24W

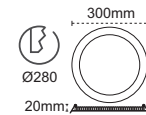

IP 40

Kod No	Özellikler	Koli Adedi	Fiyat
107926	24W 3000K	20	23,55 \$
106442	24W 4000K	20	23,55 \$
106443	24W 6500K	20	23,55 \$

Opsiyon Farkları



Kod No	Özellikler	Koli Adedi	Fiyat
313118	Slim Downlight Acil Ayd. Kiti	1	29,00 \$
313211	Triac DIM Driver (12W Slim Downlight için)	1	18,90 \$
313212	Triac DIM Driver (15W Slim Downlight için)	1	18,90 \$
313213	Triac DIM Driver (18W Slim Downlight için)	1	20,90 \$

Sırma



**Yuvarlak ve Kare
Gövde Seçeneği**

- 1W=1W çeker
- Pelsan Sırma S.Ü. LED Downlightlar beyan ettiği güç ve lümeni verir.
- Alüminyum gövde, alüminyum çerçeve
- 3 saate kadar acil aydınlatma ünite opsiyonu
- Triac ve 1-10V Dim Opsiyonu

**Sırma 18W
Sıva Üstü**

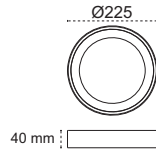

IP 20 ☺

Kod no	Özellikler	Koli Adedi	Fiyat
107999	18W 4000K	20	13,30 \$
108000	18W 6500K	20	13,30 \$

**Sırma 18W
Sıva Üstü**

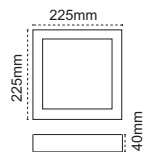

IP 20 ☺

Kod no	Özellikler	Koli Adedi	Fiyat
107997	18W 4000K	20	13,30 \$
107998	18W 6500K	20	13,30 \$

**Sırma 24W
Sıva Üstü**

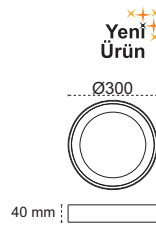

IP 20 ☺

Kod no	Özellikler	Koli Adedi	Fiyat
108316	24W 4000K	20	25,00 \$
108317	24W 6500K	20	25,00 \$

**Sırma 24W
Sıva Üstü**

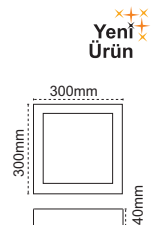

IP 20 ☺

Kod no	Özellikler	Koli Adedi	Fiyat
108312	24W 4000K	20	25,00 \$
108310	24W 6500K	20	25,00 \$

Opsiyon Farkları



IP 20 ☺

Kod no	Özellikler	Koli Adedi	Fiyat
	Radar Sensör Fiyat Farkı	1	12,85 \$
	EU Acil Aydınlatma Kiti Fiyat Farkı	1	75,20 \$

**Sırma 36W
Sıva Üstü**

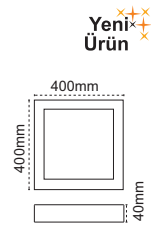
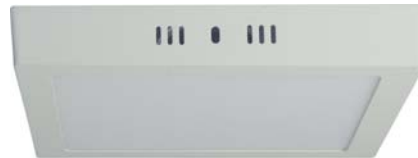

IP 20 ☺

Kod no	Özellikler	Koli Adedi	Fiyat
108344	36W 4000K	6	39,40 \$
108151	36W 6500K	6	39,40 \$

Seta Yeni Ürün



IP 40

Kod No	Özellikler	Koli Adedi	Fiyat
107907	30W COB LED 3000K	12	30,20 \$
107910	30W COB LED 4000K	12	30,20 \$

Mila Yeni Ürün



IP 40

Kod No	Özellikler	Koli Adedi	Fiyat
108008	40W COB LED 3000K	12	47,10 \$
108009	40W COB LED 4000K	12	47,10 \$

Theta



IP 40

Kod No	Özellikler	Koli Adedi	Fiyat
107982	30W COB LED 3000K	16	30,20 \$
107981	30W COB LED 4000K	16	30,20 \$

Lampda



IP 40

Kod No	Özellikler	Koli Adedi	Fiyat
108010	30W COB LED 3000K	24	30,20 \$
108011	30W COB LED 4000K	24	30,20 \$

Monofaz Ray ve Aksesuarları



Siyah Monofaz Ray ve Aksesuarları

Kod No	Özellikler	Koli Adedi	Fiyat
303845	Tek Fazlı Ray 1 Metre Siyah	1	5,20 \$
303846	Tek Fazlı Ray 2 Metre Siyah	1	10,40 \$
303847	Tek Fazlı Ray 3 Metre Siyah	1	15,60 \$
303848	Tek Fazlı Ray L Bağlantı Parçası Siyah	1	2,10 \$
303849	Tek Fazlı Ray T Bağlantı Parçası Siyah	1	2,60 \$
316066	Tek Fazlı Ray X Bağlantı Parçası Siyah	1	3,30 \$
303835	Tek Fazlı Ray I Bağlantı Parçası Siyah	1	1,60 \$
316067	Tek Fazlı Ray Son Parça - Siyah	1	1,90 \$

Beyaz Monofaz Ray ve Aksesuarları

Kod No	Özellikler	Koli Adedi	Fiyat
303839	Tek Fazlı Ray 1 Metre Beyaz	1	5,20 \$
303840	Tek Fazlı Ray 2 Metre Beyaz	1	10,40 \$
303841	Tek Fazlı Ray 3 Metre Beyaz	1	15,60 \$
303842	Tek Fazlı Ray L Bağlantı Parçası Beyaz	1	2,10 \$
303843	Tek Fazlı Ray T Bağlantı Parçası Beyaz	1	2,60 \$
316068	Tek Fazlı Ray X Bağlantı Parçası Beyaz	1	3,30 \$
303844	Tek Fazlı Ray I Bağlantı Parçası Beyaz	1	1,60 \$
316069	Tek Fazlı Ray Son Parça - Beyaz	1	1,90 \$

Pelsan LED Spot Armatürler

Cora 19 20W

165x165mm



IP 40

Kod No	Özellikler	Koli Adedi	Fiyat
107900	20W COB LED 4000K	8	33,60 \$

Cora 19 2X20W

315x165mm



IP 40

Kod No	Özellikler	Koli Adedi	Fiyat
107901	2X20W COB LED 4000K	4	66,90 \$

Cora 19 3X20W

465x165mm



IP 40

Kod No	Özellikler	Koli Adedi	Fiyat
107902	3X20W COB LED 4000K	4	99,75 \$

Nira Beyaz



IP 40

Kod No	Özellikler	Koli Adedi	Fiyat
107904	30W COB LED 4000K	12	48,75 \$

Nira Siyah

Yeni Ürün



IP 40

Kod No	Özellikler	Koli Adedi	Fiyat
108140	30W COB LED 4000K	12	48,75 \$

Sirius Star



IP 40

Kod No	Özellikler	Koli Adedi	Fiyat
204175	5W COB LED 4000K	50	8,30 \$
204174	5W COB LED 4000K	50	8,30 \$

Sirius Kristal



IP 40

Kod No	Özellikler	Koli Adedi	Fiyat
204171	2W COB LED 4000K	20	8,00 \$

Sirius Asimetrik



IP 40

Kod No	Özellikler	Koli Adedi	Fiyat
204172	3W COB LED 4000K	50	19,10 \$

Sirius Mini



IP 40

Kod No	Özellikler	Koli Adedi	Fiyat
204173	3W COB LED 4000K	100	7,00 \$

Plüton



Yönlendirilebilir gövde yapısıyla vurgulamak istediğiniz alanı aydınlatır.



Kamaşma önleyici difüzörüyle yüksek göz konforu sağlar.



Dayanıklı metal mandallarıyla montajı kolaydır



72mm

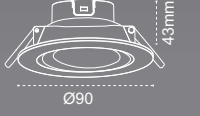

IP 40

Kod No	Özellikler	Koli Adedi	Fiyat
108454	5W 3000K	100	4,60 \$
108456	5W 6500K	100	4,60 \$

Guardi

Çift Kademeli Anahtarlı

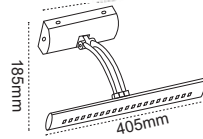

IP 20

Kod No	Özellikler	Koli Adedi	Fiyat
204551	7W Tablo Apliği 4000K	10	25,75 \$

Da Vinci

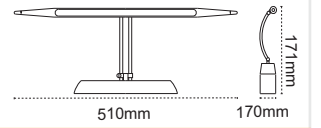

IP 20

Kod No	Özellikler	Koli Adedi	Fiyat
204544	5W Tablo Apliği 4000K	10	28,00 \$

Dali

Anahtarlı

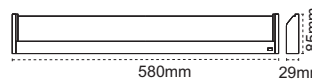

IP 40

Kod No	Özellikler	Koli Adedi	Fiyat
204547	6W Duvar Apliği 4000K	10	26,75 \$

Vien

Anahtarlı

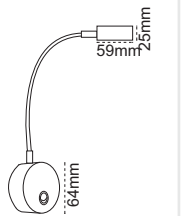

IP 20

Kod No	Özellikler	Koli Adedi	Fiyat
204569	3W 4000K	30	12,75 \$

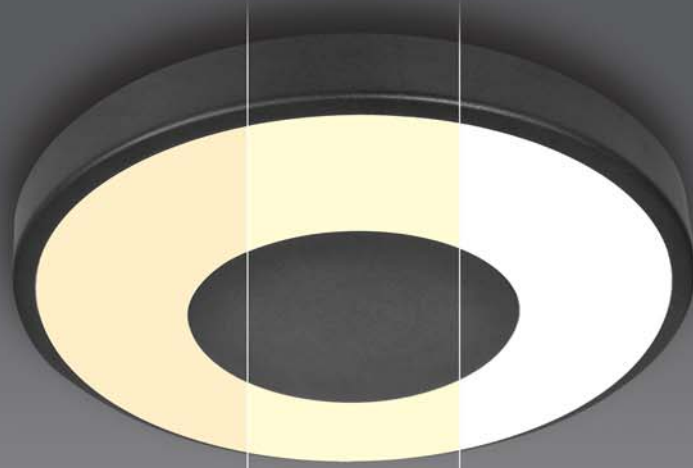

**Günün Her Saatine
Özel Dinamik Çözümler**

3000K
Akşam

4000K
Öğle

6500K
Sabah

**3 Farklı Kademede
3 Farklı Renk Sıcaklığı**

Picto Dinamik Beyaz

Yeni
Ürün



IP40

Kod No	Özellikler	Koli Adedi	Fiyat
107961	2x24W Yuvarlak Dinamik Beyaz	10	53,60 \$
107964	2x24W Kare Dinamik Beyaz	10	53,60 \$

Punto Dinamik Beyaz

Yeni
Ürün



IP 40

Kod No	Özellikler	Koli Adedi	Fiyat
107946	2x24W Yuvarlak Dinamik Beyaz	10	53,60 \$
107949	2x24W Kare Dinamik Beyaz	10	53,60 \$

Picto

Yeni
Ürün



IP 40

Kod No	Özellikler	Koli Adedi	Fiyat
107960	24W Yuvarlak 6500K	10	31,40 \$
107963	24W Kare 6500K	10	31,40 \$

Punto

Yeni
Ürün



IP 40

Kod No	Özellikler	Koli Adedi	Fiyat
107945	24W Yuvarlak 6500K	10	31,40 \$
107948	24W Kare 6500K	10	31,40 \$

Pio 35cm Yeni Ürün



Ø350mm



350mm
68mm

IP 40 ⊕

Kod No	Özellikler	Koli Adedi	Fiyat
107951	24W 6500K	10	25,00 \$
107952	2x24W Dinamik Beyaz	10	46,20 \$

Pio 35X35cm Yeni Ürün



∅ 350mm



350mm
68mm

IP 40 ⊕

Kod No	Özellikler	Koli Adedi	Fiyat
107954	24W 6500K	10	25,00 \$
107956	2x24W Dinamik Beyaz	10	46,20 \$

Opal 35cm



Ø350mm



350mm
87mm

IP 40 ⊕

Kod No	Özellikler	Koli Adedi	Fiyat
105388	23W 6500K	16	24,50 \$

Pio 25cm



Ø250mm



250mm
68mm

IP 40 ⊕

Kod No	Özellikler	Koli Adedi	Fiyat
105395	12W 6500K	10	13,75 \$

Pio 25X25cm



∅250mm



250mm
68mm

IP 40 ⊕

Kod No	Özellikler	Koli Adedi	Fiyat
105393	12W 6500K	10	13,75 \$

Opal 35x35cm



∅350mm

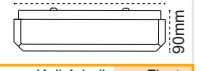

350mm
90mm

IP 40 ⊕

Kod No	Özellikler	Koli Adedi	Fiyat
105389	23W 6500K	16	24,50 \$

İlkbahar / Cemre



Ø410mm

Ø340mm



Ø340
70mm
Ø410
72mm

IP 40 ⊕

Kod No	Özellikler	Koli Adedi	Fiyat
105387	23W 6500K	10	18,90 \$
105086	23W 6500K	10	18,90 \$

Sipahi



Ø232mm



232mm
32mm
152mm

IP 40 ⊕

Kod No	Özellikler	Koli Adedi	Fiyat
104351	Sipahi E27	24	4,00 \$

Samsun



∅232mm



232mm
32mm
152mm

IP 40 ⊕

Kod No	Özellikler	Koli Adedi	Fiyat
104356	Samsun E27	24	4,00 \$

IP44 Oval Kafes
Alüminyum Enjeksiyon



axbxcmm
21 210x110x92
28 280x160x120



a b c

IP 44 ⊕

Kod No	Özellikler	Koli Adedi	Fiyat
204487	Oval Kafes 21 Gri E27	18	8,20 \$
204488	Oval Kafes 28 Gri Büyük E27	12	13,40 \$

IP44 Yaka 20
Alüminyum Enjeksiyon



190mm



190mm
106mm

IP 44 ⊕

Kod No	Özellikler	Koli Adedi	Fiyat
204476	Yaka 20 Gri E27	18	10,80 \$

IP44 Polo2
Alüminyum Enjeksiyon



190mm



190mm
130mm

IP 44 ⊕

Kod No	Özellikler	Koli Adedi	Fiyat
204561	Polo 2 Gri E27	8	18,90 \$

Havana IP66 Kare

Toz ve Su Almaz

- Pelsan Havana tavan armatürü IP66 koruma sınıfı ile çevre şartlarından etkilenmez.
- Darbe dayanımı yüksektir. Kırılmaz.
- E27, LED, LED radar sensörlü, LED acil aydınlatma kitli opsiyonları vardır.
- Paslanmaz vida ve UV ışınları ile sararmaz opal cama sahiptir.



Havana IP66 Gri

Yeni Ürün

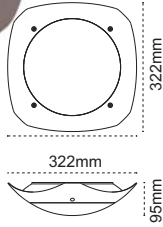

IP 66

Kod No	Özellikler	Koli Adedi	Fiyat
108273	E27 max 23W	8	16,40 \$
108279	2xE27	8	17,10 \$
108276	15W LED	8	32,30 \$
108361	15W LED Radar Sens.	8	52,30 \$
108362	15W LED Acil Ayd. Kitli	8	62,40 \$

Havana IP66 Beyaz

Yeni Ürün

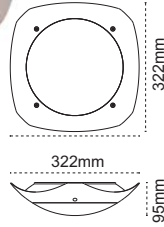

IP 66

Kod No	Özellikler	Koli Adedi	Fiyat
108367	E27 max 23W	8	16,10 \$
108368	2xE27	8	17,10 \$
108277	15W LED	8	32,30 \$
108369	15W LED Radar Sens.	8	52,30 \$
108370	15W LED Acil Ayd. Kitli	8	62,40 \$

Havana IP66 Siyah

Yeni Ürün

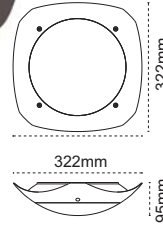

IP 66

Kod No	Özellikler	Koli Adedi	Fiyat
108363	E27 max 23W	8	16,10 \$
108364	2xE27	8	17,10 \$
108278	15W LED	8	32,30 \$
108365	15W LED Radar Sens.	8	52,30 \$
108366	15W LED Acil Ayd. Kitli	8	62,40 \$

Havana IP66 E27 Gri/Kırmızı

Yeni Ürün

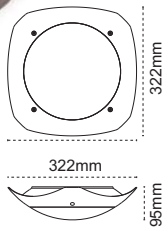

IP 66

Kod No	Özellikler	Koli Adedi	Fiyat
108467	E27 max 23W	8	16,00 \$
108358	2xE27	8	17,00 \$

Havana IP66 E27 Gri/Turuncu

Yeni Ürün

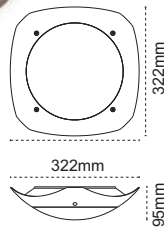

IP 66

Kod No	Özellikler	Koli Adedi	Fiyat
108469	E27 max 23W	8	16,00 \$
108360	2xE27	8	17,00 \$

Havana IP66 E27 Gri/Mavi

Yeni Ürün

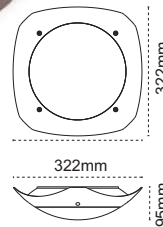

IP 66

Kod No	Özellikler	Koli Adedi	Fiyat
108468	E27 max 23W	8	16,00 \$
108359	2xE27	8	17,00 \$

Havana IP66 Yuvarlak Toz ve Su Almaz

- Pelsan Havana tavan armatürü IP66 koruma sınıfı ile çevre şartlarından etkilenmez.
- Darbe dayanımı yüksektir. Kırılmaz.
- E27, LED, LED radar sensörlü, LED acil aydınlatma kitli opsiyonları vardır.
- Paslanmaz vida ve UV ışınları ile sararmaz opal cama sahiptir.



Havana IP66 Gri

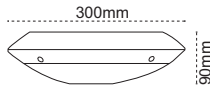

IP 66

Kod No	Özellikler	Koli Adedi	Fiyat
105090	E27 max 23W	8	14,00 \$
105122	2xE27	8	15,00 \$
105098	15W LED	8	30,20 \$
105115	15W LED Radar Sens.	8	50,20 \$
105106	15W LED Acil Ayd. Kitli	8	60,30 \$

Havana IP66 Beyaz

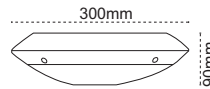

IP 66

Kod No	Özellikler	Koli Adedi	Fiyat
105092	E27 max 23W	8	14,00 \$
105124	2xE27	8	15,00 \$
105101	15W LED	8	30,20 \$
105118	15W LED Radar Sens.	8	50,20 \$
105109	15W LED Acil Ayd. Kitli	8	60,30 \$

Havana IP66 Siyah

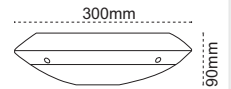

IP 66

Kod No	Özellikler	Koli Adedi	Fiyat
105091	E27 max 23W	8	14,00 \$
105123	2xE27	8	15,00 \$
105104	15W LED	8	30,20 \$
105121	15W LED Radar Sens.	8	50,20 \$
105112	15W LED Acil Ayd. Kitli	8	60,30 \$

Havana IP66 E27 Gri/Kırmızı

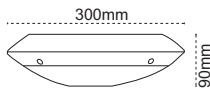

IP 66

Kod No	Özellikler	Koli Adedi	Fiyat
105093	E27 max 23W	8	16,00 \$
108464	2xE27	8	17,00 \$

Havana IP66 E27 Gri/Turuncu

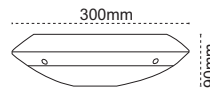

IP 66

Kod No	Özellikler	Koli Adedi	Fiyat
105095	E27 max 23W	8	16,00 \$
108466	2xE27	8	17,00 \$

Havana IP66 E27 Gri/Mavi

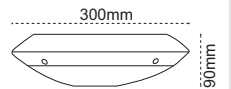

IP 66

Kod No	Özellikler	Koli Adedi	Fiyat
105094	E27 max 23W	8	16,00 \$
108465	2xE27	8	17,00 \$

360° Hareket Sensörü

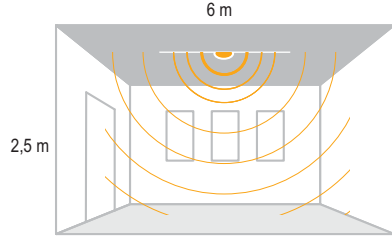

3 gözlü teknoloji ile çok geniş bir alanı tarayarak her yönden algılama yapar.

IP 20

Kod No	Özellikler	Koli Adedi	Fiyat
314720	360 Derece Hareket Sensörü	50	8,70 \$

180° Hareket Sensörü

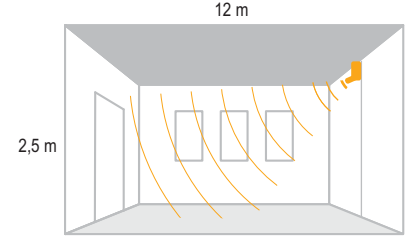

IP 20

Kod No	Özellikler	Koli Adedi	Fiyat
314717	180 Derece Hareket Sensörü	50	8,10 \$

Mini Hareket Sensörü

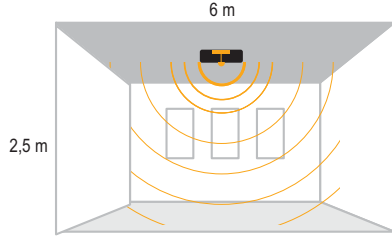

Sensör uygulama alanında karşılaşılan mekanik yerleşim sorunlarını gidermek için pratik kullanım sağlar.

IP 20

Kod No	Özellikler	Koli Adedi	Fiyat
314732	Mini Hareket Sensörü	100	8,10 \$

Radar Sensör

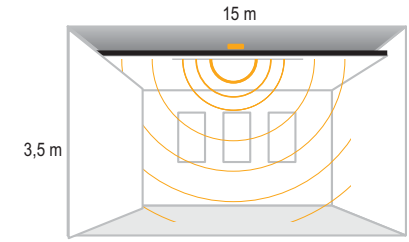

Sıva altı, gizli, armatür içi ve dışı uygulamalarda en iyi çözüm.

IP 20

Kod No	Özellikler	Koli Adedi	Fiyat
314725	Radar Sensör	100	13,60 \$

Sıva Altı Tavan Sensör

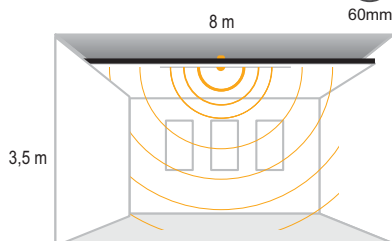

Zaman, Lux ve mesafe ayarlama özelliği ile sıva altı uygulamalar için ideal çözüm

IP 20

Kod No	Özellikler	Koli Adedi	Fiyat
5314726	Sıva Altı Tavan Sensör	50	9,90 \$

Sıva Altı Tavan Sensör Küçük

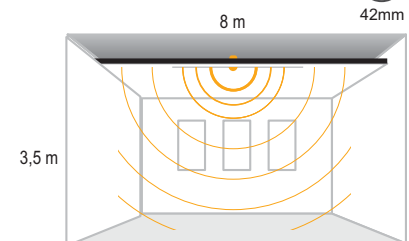

Zaman, Lux ve mesafe ayarlama özelliği ile sıva altı uygulamalar için ideal çözüm

IP 20

Kod No	Özellikler	Koli Adedi	Fiyat
314731	Sıva Altı Tavan Sensör Küçük	100	9,90 \$

IP65 Sensör Kutusu



Dış mekanlarda kolaylıkla sensör kullanmanızı sağlar.

IP 65

Kod No	Özellikler	Koli Adedi	Fiyat
314735	IP65 Sensör Kutusu	50	10,00 \$

Fotosel

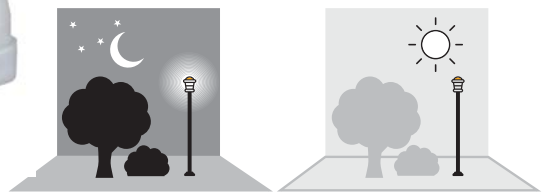

Gece gündüz farkını algılayarak dış mekan aydınlatmalarında kontrol sağlar.

IP 65

Kod No	Özellikler	Koli Adedi	Fiyat
314738	Fotosel	100	5,20 \$

Varlık Sensörü



IP 20

Kod No	Özellikler	Koli Adedi	Fiyat
314733	Varlık Sensörü	50	22,20 \$

Dört Yönlü Hareket Sensörü

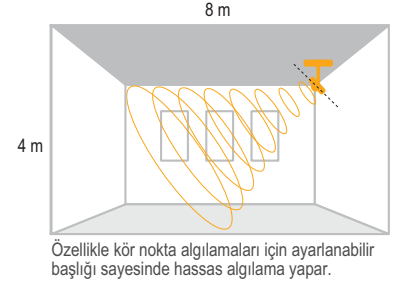

IP 20

Kod No	Özellikler	Koli Adedi	Fiyat
314729	Dört Yönlü Hareket Sensörü	100	13,30 \$

İç Sensör

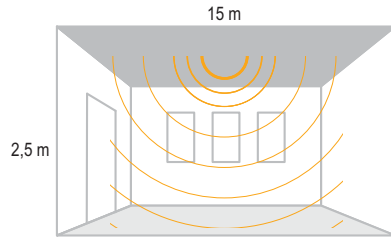

IP 20

Kod No	Özellikler	Koli Adedi	Fiyat
314724	İç Sensör	100	10,30 \$

Yüksek Tavan Sensörü

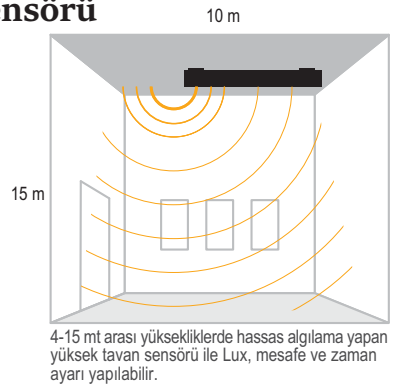

IP 20

Kod No	Özellikler	Koli Adedi	Fiyat
314730	Yüksek Tavan Sensörü	50	31,60 \$

Duyulu Hareket Sensörü

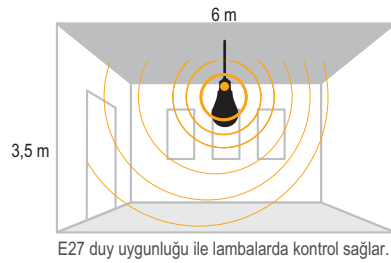

IP 20

Kod No	Özellikler	Koli Adedi	Fiyat
314722	Duyulu Hareket Sensörü	50	10,20 \$

Anahtar Sensör

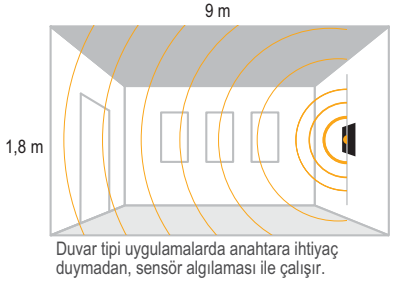

IP 20

Kod No	Özellikler	Koli Adedi	Fiyat
314723	Anahtar Sensör	50	9,90 \$

İç Sensör + LED Driver (15W)

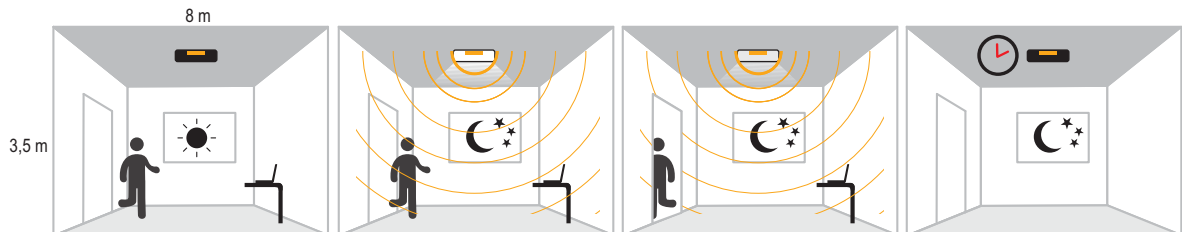

Sürücü ünitesi ile birleşik, multifonksiyonel aydınlatma kontrolü. Gün ışığı sensörü ile radar teknolojisini bir arada kullanarak maksimum verimliliği yakalayın.

IP 20

Kod No	Özellikler	Koli Adedi	Fiyat
314737	Radar Sensörlü Dim Driver 27W (30-45V /DC 600 mA)	50	30,75 \$
314736	Radar Sensörlü Dim Driver 15W (30-51V /DC 300 mA)	50	27,75 \$

Sense



Işık Tam Zamanında Yansın!

- Time butonu ile lambanın ne kadar süreyle yanacağı,
- Sens butonu ile lambanın ne kadar mesafeden hareketi algılayıp yanacağı ayarlanabilir.
- (-) işareti yükün yalnızca gece (+) işareti gündüz ve gece açık olacağını belirtir.
- Max.montaj yüksekliği 4.5m'dir.

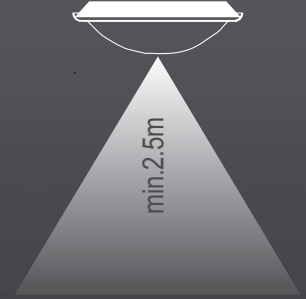

Sense Acil Sensörlü

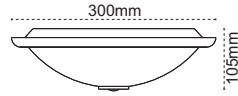

IP 20 ☉

Kod No	Özellikler	Koli Adedi	Fiyat
104367	2xE27 Sensörlü + Acil Ayd.	10	39,00 \$

Senseled Sensörlü

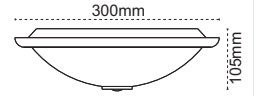

IP 20 ☉

Kod No	Özellikler	Koli Adedi	Fiyat
104364	6W LED Sensörlü	10	29,50 \$

Senseled Acil Sensörlü

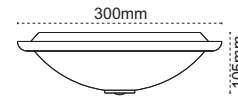

IP 20 ☉

Kod No	Özellikler	Koli Adedi	Fiyat
104369	8W LED Sensörlü + Acil Ayd.	10	41,10 \$

Sense & Sense Sensörlü

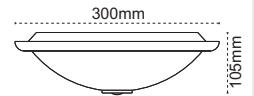

IP 20 ☉

Kod No	Özellikler	Koli Adedi	Fiyat
104357	2xE27 Sense	10	11,80 \$
104359	2XE27 Sense Sensörlü	10	14,75 \$

IP66 Havana Radar Sensörlü

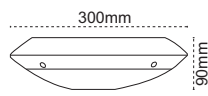

IP 66 ☉

Kod No	Özellikler	Koli Adedi	Fiyat
105115	15W LED Radar Sensörlü	8	50,20 \$

IP66 Havana Acil Aydınlatma Kitli

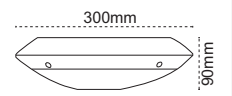

IP 66 ☉

Kod No	Özellikler	Koli Adedi	Fiyat
105106	15W LED Acil Aydınlatma Kitli	8	60,30 \$

Işığa Hareket Kazandırır

Multiline LED Lineer Armatür

Multiline lineer armatür, mağaza, market, ofis ve depolarda ışığın istenen yönde iletilmesini sağlayan hareketli sistemi, modern endüstriyel tasarımı ile yönlendirilebilir lineer aydınlatma sağlar.

Işığı istediğiniz noktaya yönlendirir.

7 kademeli ayarlanabilir ışık açısı ile pratik bir şekilde istediğiniz yere ışığı yönlendirebilirsiniz. (15°- 105°)



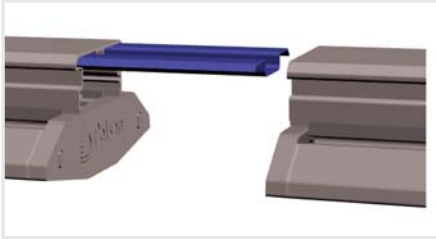
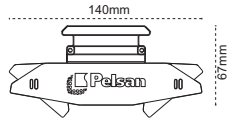

Multiline LED Lineer Armatür

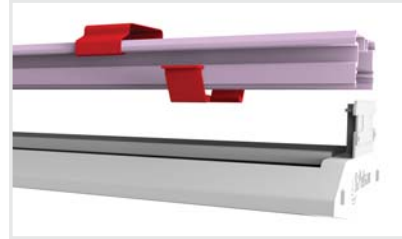

Sürekli lineer aydınlatma oluşturur.
Lineer bağlantı için tasarlanmış yan kapaklar ve bağlantı aparatı ile kesintisiz ışık imkanı verir.



Kurulum kolaylığı sağlar.
2 parçadan oluşan Multiline LED lineer armatürü kolay ve güvenli bir şekilde monte edebilirsiniz.

-  Avrupa menşeli LED çip ve driver
-  120 lm/W verimlilik
-  Alüminyum gövde ile dayanıklı, estetik ve hafif
-  Sıva üstü veya sarkıt uygulaması
-  Kamaşma engelleyici özel difüzörlü

Opsiyonlar

-  Acil aydınlatma kiti (1-3 saat)
-  DALI 1-10V Dim
-  120cm / 150cm boy
-  3000K-4000K-6500K
-  Buzlu ve şeffaf cam



IP 40

Kesintisiz Lineer Bağlantılı

Kod No	Özellikler	Koli Adedi	Fiyat	Kod No	Özellikler	Koli Adedi	Fiyat
105381	35W 6500K 120cm Opal Difüzör	4	153,75 \$	108508	35W 6500K 120cm Opal Difüzör	4	156,25 \$
105383	35W 6500K 150cm Opal Difüzör	4	167,00 \$	108509	35W 6500K 150cm Opal Difüzör	4	169,25 \$
105385	50W 6500K 150cm Opal Difüzör	4	194,00 \$	108416	50W 6500K 150cm Opal Difüzör	4	196,25 \$

Linea Large LED

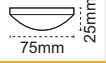

IP 40 ⊕

Kod No	Özellikler	Koli Adedi	Fiyat
107932	18W 4000K 60cm	20	15,70 \$
107933	18W 6500K 60cm	20	15,70 \$
107938	36W 4000K 120cm	20	17,70 \$
107939	36W 6500K 120cm	20	17,70 \$

Linea LED



Kesintisiz Linear Bağlantı



Anahtarlı

Aparatlar fiyata dahildir.

(Enerji kablosu, 15 cm esnek bağlantı aparatı, mini bağlantı aparatı, zemin montajı için gerekli klipsler, bitiş kapağı)



IP 40 ⊕

Kod No	Özellikler	Koli Adedi	Fiyat
204672	4W 6500K 30cm	30	6,00 \$
204673	8W 6500K 60cm	30	8,25 \$
204671	16W 6500K 120 cm	30	12,75 \$
306960	Fiş Kablo	150	2,10 \$

Linea LED IP65

Yeni
Ürün



IP65



IP 65 ⊕

Kod No	Özellikler	Koli Adedi	Fiyat
204679	36W 4000K 120 cm IP65	10	23,40 \$
204678	36W 6500K 120 cm IP65	10	23,40 \$

Clear LED

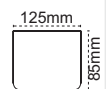

IP 40 ⊕

Kod No	Özellikler	Koli Adedi	Fiyat
105713	36W 6500K 120 cm	10	47,50 \$

Etanj Duyulu Sac Bant LED Tube Uygun



IP 20

Kod No	Özellikler	Koli Adedi	Fiyat
103220	Tekli 60cm	6	11,60 \$
103229	Tekli 120cm	6	14,30 \$
103281	Tekli 150cm	6	17,00 \$
103239	İkili 60cm	6	14,00 \$
103247	İkili 120cm	6	16,70 \$
103272	İkili 150cm	6	19,60 \$

Etanj Duyulu Polyester Bant LED Tube Uygun



IP 65

Kod No	Özellikler	Koli Adedi	Fiyat
103200	Tekli 120cm	6	19,00 \$
103210	İkili 120cm	6	21,60 \$
103261	Tekli 150cm	6	20,60 \$
103268	İkili 150cm	6	23,20 \$

T8 Etanj Duyulu Sac Bant



IP 20

Kod No	Özellikler	Koli Adedi	Fiyat
103223	1x18W T8 Etanj Duyulu Sac Bant Elek. Bal.	6	28,60 \$
103242	2x18W T8 Etanj Duyulu Sac Bant Elek. Bal.	6	31,20 \$
103233	1x36W T8 Etanj Duyulu Sac Bant Elek. Bal.	6	29,80 \$
103252	2x36W T8 Etanj Duyulu Sac Bant Elek. Bal.	6	32,40 \$
103284	1x58W T8 Etanj Duyulu Sac Bant Elek. Bal.	6	31,20 \$
103275	2x58W T8 Etanj Duyulu Sac Bant Elek. Bal.	6	33,90 \$

T8 Etanj Duyulu Polyester Bant



IP 65

Kod No	Özellikler	Koli Adedi	Fiyat
103204	1x36W T8 Polyester Bant Elek. Bal.	6	33,90 \$
103214	2x36W T8 Polyester Bant Elek. Bal.	6	36,50 \$
103264	1x58W T8 Polyester Bant Elek. Bal.	6	35,30 \$
103269	2x58W T8 Polyester Bant Elek. Bal.	6	38,00 \$

TMS LED Tube Uygun



IP 20

Kod No	Özellikler	Koli Adedi	Fiyat
100371	TMS Tekli 60cm	12	3,95 \$
100372	TMS Tekli 120cm	12	4,95 \$
100373	TMS Tekli 150cm	12	5,55 \$
100231	TMS İkili 60cm	6	8,20 \$
100270	TMS İkili 120cm	6	9,70 \$
100361	TMS İkili 150cm	6	10,60 \$

T8 TMS Floresan



IP 20

Kod No	Özellikler	Koli Adedi	Fiyat
100223	1x18W TMS T8 Floresan Elek. Bal.	6	16,00 \$
100236	2x18W TMS T8 Floresan Elek. Bal.	6	16,50 \$
100215	1x15W TMS T8 Floresan Elek. Bal.	6	16,00 \$
100246	1x30W TMS T8 Floresan Elek. Bal.	6	16,50 \$
100260	1x36W TMS T8 Floresan Elek. Bal.	6	16,90 \$
100277	2x36W TMS T8 Floresan Elek. Bal.	6	21,10 \$
100357	1x58W TMS T8 Floresan Elek. Bal.	6	22,80 \$
100364	2x58W TMS T8 Floresan Elek. Bal.	6	26,00 \$

Market Armatürü LED Tube Uygun

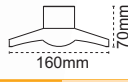

IP 20

Kod No	Özellikler	Koli Adedi	Fiyat
105331	T8 Market Arm. 1x18W 120 cm	5	36,80 \$
105332	T8 Market Arm. 1x24W 150 cm	5	41,00 \$

T5 Market Armatürü

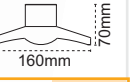

IP 20

Kod No	Özellikler	Koli Adedi	Fiyat
105335	1x28W Elek. Bal. TL5	1	38,60 \$
105339	2x28W Elek. Bal. TL5	1	42,10 \$
105342	1x35W Elek. Bal. TL5	1	42,10 \$
105344	2x35W Elek. Bal. TL5	1	45,60 \$
105348	1x54W Elek. Bal. TL5	1	38,60 \$
105353	2x54W Elek. Bal. TL5	1	42,10 \$
105358	1x80W Elek. Bal. TL5	1	56,30 \$
105361	2x80W Elek. Bal. TL5	1	59,90 \$

Yedek Parçalar

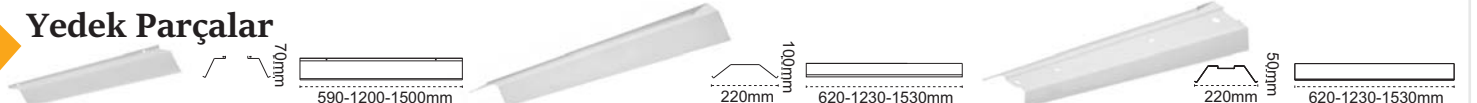

Kod No	Özellikler	Koli Adedi	Fiyat	Kod No	Özellikler	Koli Adedi	Fiyat	Kod No	Özellikler	Koli Adedi	Fiyat
311845	Standart TMS 18W Ref.	10	4,70 \$	311836	Geçmeli Bant 18W Ref.	10	5,50 \$	311840	Etanj Duyulu Sac Bant 18W Ref.	10	4,70 \$
311846	Standart TMS 36W Ref.	10	5,50 \$	311837	Geçmeli Bant 36W Ref.	10	7,50 \$	311841	Etanj Duyulu Sac Bant 36W Ref.	10	6,10 \$
311847	Standart TMS 58W Ref.	10	7,20 \$	311838	Geçmeli Bant 58W Ref.	10	9,10 \$	311842	Etanj Duyulu Sac Bant 58W Ref.	10	7,10 \$
								311851	Etanj Duyulu Poly. Bant 36W Ref.	10	7,50 \$
								311852	Etanj Duyulu Poly. Bant 58W Ref.	10	9,40 \$

Forza



Kolay Montaj



2x18W LED Tube



120 cm



Birebir Dönüşüme Uygunur

2x36W Floresan Etanj armatür ışık çıktısını
2x18W Pelsan LED Tube ile birebir sağlar..



Dahili LED Tube

LED'e Özgü
Mandalsız
Tasarım

IP65



Kolay ve Hızlı Montaj

Fonksiyonel tasarıma sahip Forza, içine müdahale edilmeksizin yüzey ve kablo tavalarına kolay ve hızlı montaj edilir.



Opsiyonel Lineer Bağlantı

İki tarafında bulunan klemens kapağı ile lineer bağlantıya uygundur.

Forza LED



Yeni
Ürün



IP 65

Kod No	Özellikler	Koli Adedi	Fiyat
108118	36W 4000K 120cm LED	6	43,30 \$
108119	36W 6500K 120cm LED	6	43,30 \$
108120	2x18W 4000K 120cm LED Tube Dahil	6	31,75 \$
108407	2x18W 6500K 120cm LED Tube Dahil	6	31,75 \$

Largo LED



IP 65

Kod No	Özellikler	Koli Adedi	Fiyat
105727	20W 6500K 60cm	6	36,50 \$
105722	20W 6500K 120cm	6	38,75 \$
105719	36W 6500K 120cm	6	40,50 \$
105721	36W 6500K 120cm Acil Aydınlatma Kiti	6	67,75 \$
108519	45W 6500K 150cm	6	80,75 \$

Largo LED Lux



IP 65

Kod No	Özellikler	Koli Adedi	Fiyat
105867	17W 6500K 60cm	6	50,50 \$
105881	42W 6500K 120cm	6	58,75 \$
105892	45W 6500K 150cm	6	97,75 \$

Largo LED Tube Tekli Şeffaf Cam



IP 65 • Acil aydınlatma kiti uygulanabilir (9-18W)

Kod No	Özellikler	Koli Adedi	Fiyat
102669	LED Tube Tekli 60cm	6	13,50 \$
102713	LED Tube Tekli 120cm	6	17,90 \$
102867	LED Tube Tekli 150cm	6	26,00 \$
313117	9-18W LED Tube Konvertör Kiti	100	52,60 \$

Largo LED Tube İkili Şeffaf Cam



IP 65 • Acil aydınlatma kiti uygulanabilir (9-18W)

Kod No	Özellikler	Koli Adedi	Fiyat
102687	LED Tube İkili 60cm	6	14,75 \$
102744	LED Tube İkili 120cm	6	20,25 \$
102878	LED Tube İkili 150cm	6	31,00 \$
313117	9-18W LED Tube Konvertör Kiti	100	52,60 \$

Largo LED Frozen -40°C'ye kadar



IP 65 • Soğuk hava depoları ve donuk ürün depoları kullanımı için uygundur.

Kod No	Özellikler	Koli Adedi	Fiyat
105871	21W 6500K 60cm (-25°C)	6	127,00 \$
105884	42W 6500K 120cm (-40°C)	6	245,00 \$
105894	63W 6500K 150cm (-40°C)	6	363,00 \$

Largo T8

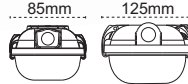

IP 65

Kod No	Özellikler	Koli Adedi	Fiyat
102677	Largo 1x18W Elek. Bal. TLD	6	25,00 \$
102697	Largo 2x18W Elek. Bal. TLD	6	27,70 \$
102724	Largo 1x36W Elek. Bal. TLD	6	30,00 \$
102754	Largo 2x36W Elek. Bal. TLD	6	33,10 \$
102872	Largo 1x58W Elek. Bal. TLD	6	39,40 \$
102881	Largo 2x58W Elek. Bal. TLD	6	44,30 \$

Solta T8 IP65 Etanj

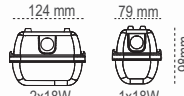

IP 65 • PC Gövde / PC Cam

Kod No	Özellikler	Koli Adedi	Fiyat
102902	1X18W Elek. Bal. TLD	6	28,75 \$
102908	2X18W Elek. Bal. TLD	6	29,50 \$
102916	1X36W Elek. Bal. TLD	6	34,50 \$
102924	2X36W Elek. Bal. TLD	6	40,75 \$

Mar Etanj

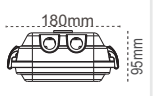

IP 65

Kod No	Özellikler	Koli Adedi	Fiyat
203140	LED Tube Üçlü 60cm	4	28,60 \$
203143	LED Tube Dörtlü 60cm	4	29,70 \$
102569	LED Tube Üçlü 120cm	4	39,20 \$
102574	LED Tube Dörtlü 120cm	4	40,30 \$
102577	LED Tube Üçlü 150cm	4	60,40 \$
102579	LED Tube Dörtlü 150cm	4	61,50 \$

Solida



Alüminyum
Gövde

IP65

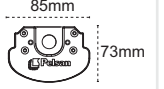

IP 65

Kod No	Özellikler	Koli Adedi	Fiyat
105599	23W 6500K 60cm	6	74,25 \$
105603	35W 6500K 90cm	6	95,75 \$
105606	45W 6500K 120cm	6	127,25 \$
105609	65W 6500K 120cm	6	168,75 \$

Prota



Alüminyum
Gövde

IP65



IP 65

Kod No	Özellikler	Koli Adedi	Fiyat
105611	23W 6500K 60cm	6	63,50 \$
105614	35W 6500K 90cm	6	85,00 \$
105618	45W 6500K 120cm	6	116,50 \$
105621	65W 6500K 120cm	6	159,25 \$

Inovaled IP66

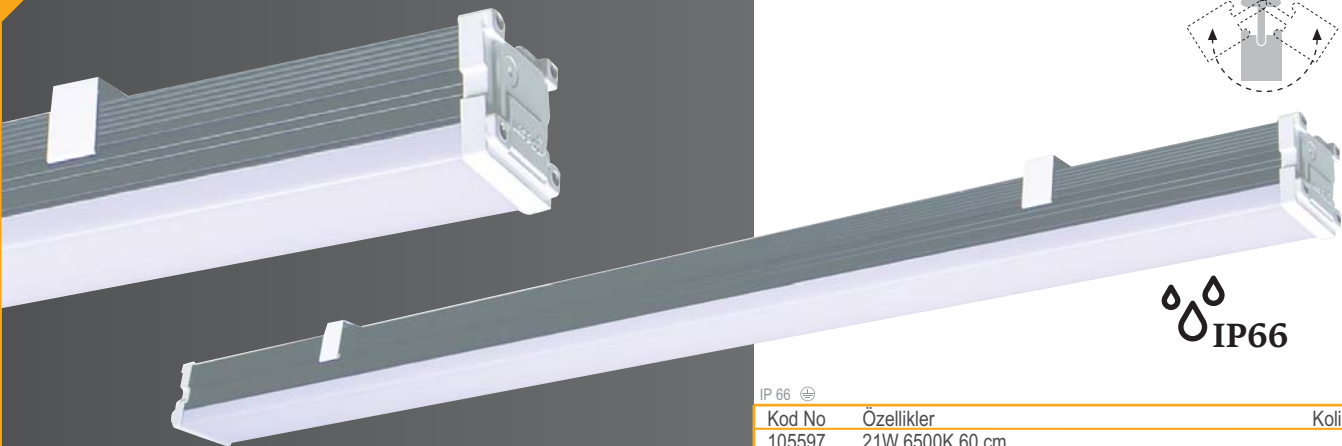

Açı Ayarlı Montaj Aparatı

Alüminyum
Gövde

IP66

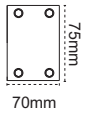

IP 66

Kod No	Özellikler	Koli Adedi	Fiyat
105597	21W 6500K 60 cm	6	68,00 \$
105593	42W 6500K 120 cm	6	102,00 \$
105585	45W 6500K 150 cm	6	132,50 \$
311186	Açı Ayarlı Montaj Aparatı 2'li	6	7,00 \$

2x10W Emergency Spot



Acil Durumlar
Pelsan Güvencesinde

2x10W LEDli 6 Saat



IP 40

Kod No	Özellikler	Koli Adedi	Fiyat
203907	2x10W LEDli 6 Saat	8	108,20 \$

2x5W LEDli 4 Saat



IP 40

Kod No	Özellikler	Koli Adedi	Fiyat
203913	2x5W LEDli 4 Saat	8	59,10 \$

2x3W LEDli 6 Saat



IP 40

Kod No	Özellikler	Koli Adedi	Fiyat
203911	2x3W LEDli 5 Saat	10	30,20 \$

LEDli Işıldak 8 Saat

Yeni
Ürün



IP 65

Kod No	Özellikler	Koli Adedi	Fiyat	Kod No	Özellikler	Koli Adedi	Fiyat	Kod No	Özellikler	Koli Adedi	Fiyat
204623	90 LEDli Işıldak20		22,00 \$	204620	40-60 LEDli Işıldak	24	13,50 \$	204619	30 LEDli Işıldak	40	7,75 \$

200 Çeşit Etiket Opsiyonu!



• 200 çeşit etiket opsiyonu 200511, 200541, 200379, 200205 kodları için geçerlidir.

• Ürün Kodu ile birlikte etiket seçiminizi bildiriniz.



S.A Exiled Exit Etiket Opsiyonu

opsiyonlu etiket

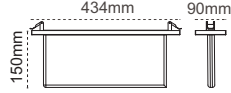

IP 20

Kod No	Özellikler	Koli Adedi	Fiyat
200511	S.A Tek Yön Opsiyonlu Exiled	10	20,10 \$
200545	S.A Çift Yön Opsiyonlu Exiled	10	25,00 \$

Exiled Exit Etiket Opsiyonu

opsiyonlu etiket

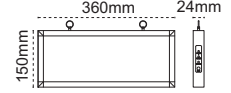

IP 20

Kod No	Özellikler	Koli Adedi	Fiyat
200379	Tek Yön Opsiyonu Exiled	10	15,20 \$
200205	Çift Yön Opsiyonlu Exiled	10	20,10 \$

Exiled Exit Tek Yön

sabit etiketli

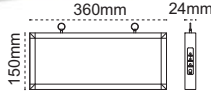

IP 20

Kod No	Özellikler	Koli Adedi	Fiyat
203891	Tek Yön 3W 3 Saat	10	9,00 \$

Exiled Exit Çift Yön

sabit etiketli

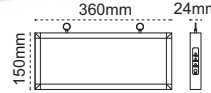

IP 20

Kod No	Özellikler	Koli Adedi	Fiyat
203885	Çift Yön 3W 3 Saat	10	9,00 \$

Exiled Exit Çift Yön

sabit etiketli

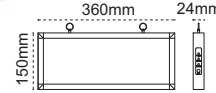

IP 20

Kod No	Özellikler	Koli Adedi	Fiyat
203890	Çift Yön 3W 3 Saat	10	9,00 \$

Exiled Exit Çift Yön

sabit etiketli

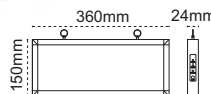

IP 20

Kod No	Özellikler	Koli Adedi	Fiyat
203888	Çift Yön 3W 3 Saat	10	9,00 \$

Exiled Exit Çift Yön

sabit etiketli

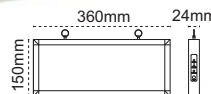

IP 20

Kod No	Özellikler	Koli Adedi	Fiyat
203889	Çift Yön 3W 3 Saat	10	9,00 \$

Exiled Exit Çift Yön

sabit etiketli

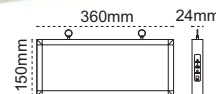

IP 20

Kod No	Özellikler	Koli Adedi	Fiyat
203887	Çift Yön 3W 3 Saat	10	9,00 \$

Vialed Sarkıt

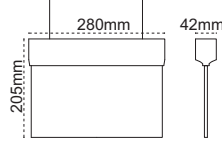

IP 20

Kod No	Özellikler	Koli Adedi	Fiyat
201136	Tek Yön Sarkıt 3W E5 Etiket	1	34,50 \$
201165	Çift Yön Sarkıt 3W E5 Etiket	1	38,25 \$

S.Ü.Vialed

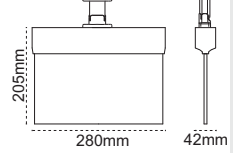

IP 20

Kod No	Özellikler	Koli Adedi	Fiyat
200944	Mafsallı Tek Yön Exit 3W E5 Etiket	1	34,50 \$
201013	Mafsallı Çift Yön Exit 3W E5 Etiket	1	38,25 \$

S.A Vialed

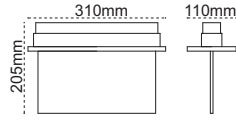

IP 20

Kod No	Özellikler	Koli Adedi	Fiyat
201064	S.A Tek Yön 3W E5 Etiket	1	43,25 \$
201110	S.A Çift Yön 3W E5 Etiket	1	47,00 \$

Ufo Acil Aydınlatma Spotu

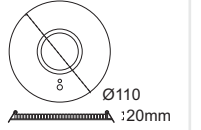

IP 20

Kod No	Özellikler	Koli Adedi	Fiyat
204463	3W 3000K (2'li)	20	59,00 \$

24 LEDli Emergency

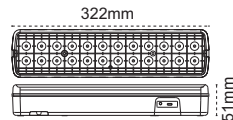

● Exit / Çıkış etiketi hediye

IP 20

Kod No	Özellikler	Koli Adedi	Fiyat
203905	24 LEDli Emergency	20	16,20 \$

Ausled IP65 Emergency AC/DC

Yeni Ürün

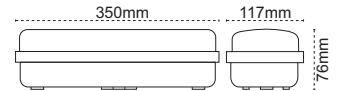

● Dört farklı yönlendirme etiketi hediye

IP 65

Kod No	Özellikler	Koli Adedi	Fiyat
108390	5W 6500K	12	40,50 \$

Clear

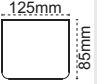

IP 40

Kod No	Özellikler	Koli Adedi	Fiyat
105713	Clear LED 36W 6500K 120 CM	1	47,50 \$
102381	T1 Clear 1X18W 6500K T8 Arm. Elek. Bal.	1	22,70 \$
102392	T1 Clear 2X18W 6500K T8 Arm. Elek. Bal.	1	27,40 \$
102403	T1 Clear 1X36W 6500K T8 Arm. Elek. Bal.	1	28,30 \$
102417	T1 Clear 2X36W 6500K T8 Arm. Elek. Bal.	1	34,10 \$

Plex

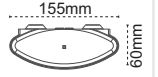

IP 40

Kod No	Özellikler	Koli Adedi	Fiyat
102513	Opal 2x18W Elek. Bal. TLD	1	28,30 \$
102521	Opal 2x36W Elek. Bal. TLD	1	35,00 \$

Linea Large LED



IP 40

Kod No	Özellikler	Koli Adedi	Fiyat
107932	18W 4000K 60cm	20	15,70 \$
107933	18W 6500K 60cm	20	15,70 \$
107938	36W 4000K 120cm	20	17,70 \$
107939	36W 6500K 120cm	20	17,70 \$

Linea IP65 LED



Yeni Ürün

IP65



IP 40

Kod No	Özellikler	Koli Adedi	Fiyat
204679	36W 4000K 120cm IP65	10	23,40 \$
204678	36W 6500K 120cm IP65	10	23,40 \$

Linea LED



Kesintisiz Lineer Bağlantı



IP 40

Kod No	Özellikler	Koli Adedi	Fiyat
204672	4W 6500K 30cm	30	6,00 \$
204673	8W 6500K 60cm	30	8,25 \$
204671	16W 6500K 117,3cm	30	12,75 \$
306960	Fiş Kablo	150	2,10 \$



Aparatlar fiyata dahildir.
(Enerji kablosu, 15 cm esnek bağlantı aparatı, mini bağlantı aparatı, zemin montajı için gerekli klipsler, bitiş kapağı)

Etna

Tüm Endüstriyel Tesislerde Yüksek Performans



İşletmelerinize Yüksek Kazanç Sağlar!
+150lm/W etkinlik faktörü ile yüksek verimlidir.
Floresan armatürlere göre %50,
MH armatürlere göre %70 tasarruf sağlar.



Farklı İhtiyaçlara Uygun Sektörel Çözümler!
Projeye özel optik çözümler.
Entegre yüksek tavan sensörü
Tüm kontrol sistemlerine uygun
4 farklı güç seçeneği



Zorlu Ortam Koşullarına Dayanıklısıdır!
Toz ve su almaz, IP65
Darbe dayanımı yüksek gövde (IK09)
Temperli cam (IK08)



Etna Uzun Ömürlüdür! Bakım Gerektirmez!
EU LED çip & sürücü
Etkin soğutma sağlayan alüminyum gövde

 IP65 IK09



Etna LED

IP65 Yüksek Tavan Armatürü

Yeni Ürün  Alüminyum Gövde





Sensör Uygulaması



180mm

86mm

a

IP 65  Dar Açı					IP 65  Geniş Açı				
Kod No	Özellikler	a (mm)	Koli Adedi	Fiyat	Kod No	Özellikler	a (mm)	Koli Adedi	Fiyat
108526	80W 6500K	120cm	1	218,00 \$	108527	80W 6500K	120cm	1	218,00 \$
108524	100W 6500K	120cm	1	259,00 \$	108525	100W 6500K	120cm	1	259,00 \$
108532	125W 6500K	150cm	1	311,00 \$	108533	125W 6500K	150cm	1	311,00 \$
108534	140W 6500K	150cm	1	363,00 \$	108535	140W 6500K	150cm	1	363,00 \$

Hima LED

IP65 Yüksek Tavan Armatürü

Yeni Ürün  Alüminyum Gövde



Sensör Uygulaması



80mm

155mm

1270mm

IP 65 				
Kod No	Özellikler	Koli Adedi	Fiyat	
108225	Hima LED 75W 6500K	1	135,00 \$	
108372	Hima LED 75W 6500K Sensörlü	1	168,75 \$	
108373	Hima LED 75W 6500K Sensörlü Kiti	1	257,50 \$	

Pelsan Yüksek Tavan Armatürleri

Castor

IP65 LED Yüksek Tavan Armatürü

Alüminyum
Enjeksiyon



100W



150W



200W

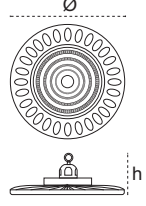

Askı Zinciri ile Kolay Montaj!

IP 65

axbxcmm
100W:295x295x90
150W:345x345x95
200W:395x395x105

Kod No	Özellikler	Koli Adedi	Fiyat	Kod No	Özellikler	Koli Adedi	Fiyat	Kod No	Özellikler	Koli Adedi	Fiyat
107995	100W 5700K	6	111,50 \$	108122	150W 5700K	4	179,00 \$	107996	200W 5700K	3	235,00 \$

Karpat LED

IP65 Yüksek Tavan Armatürü



110 lm/W

axbxcmm
36W:1210x90x73
82W:1210x190x73
120W:1210x345x73
164W:1210x345x73

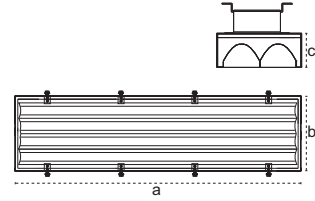

IP 65

Kod No	Özellikler	Koli Adedi	Fiyat
105842	36W 6500K	1	107,00 \$
105824	82W 6500K	1	147,00 \$
105847	120W 6500K	1	199,50 \$
105832	164W 6500K	1	259,75 \$
	Acil Aydınlatma Kit Farkı	1	72,00 \$

Karpat LED Performans

IP65 Yüksek Tavan Armatürü



130 lm/W

axbxcmm
40W:1210x90x73
75W:1210x190x73
110W:1210x345x73
150W:1210x345x73

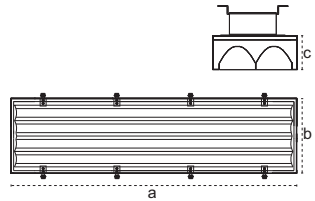

IP 65

Kod No	Özellikler	Koli Adedi	Fiyat
105902	40W 6500K Performans	1	122,50 \$
105904	75W 6500K Performans	1	160,50 \$
105908	110W 6500K Performans	1	245,50 \$
105910	150W 6500K Performans	1	282,50 \$

Karpat LED Frozen

IP65 Yüksek Tavan Armatürü

-40°C dereceye kadar düşük sıcaklıkta yüksek verimle çalışma



axbxcmm
42W:1210x90x73
82W:1210x190x73
120W:1210x345x73
164W:1210x345x73

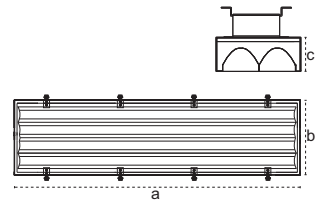

IP 65

Kod No	Özellikler	Koli Adedi	Fiyat
107915	42W 6500K Frozen	1	240,00 \$
105826	82W 6500K Frozen	1	465,00 \$
105836	164W 6500K Frozen	1	620,00 \$

Sia IP65 LED Yüksek Tavan Armatürü

Opsiyonlar

- Dar, geniş, asimetrik lens seçenekleri
- DALI dim
- Siyah, beyaz, gri renk opsiyonu



- Power LED 100.000 saati aşan ömür
- Alüminyum enjeksiyon gövde
- 120 lümen /W 'a varan verimlilik
- 1-10V dim standart 2-Step dim standart
- 15-25 metre yüksek tavan uygulaması
- Temperli cam ile güvenli

Alüminyum
Enjeksiyon

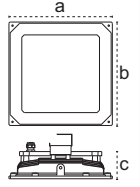

axbxcmm
75W 342x342x123
100W 342x342x123
125W 342x342x123

IP 65

Kod No	Özellikler	Koli Adedi	Fiyat
108589	75W 6500K EU Driver	1	265,00 \$
108600	100W 6500K EU Driver	1	307,00 \$
107929	100W 6500K	1	245,00 \$
106634	125W 6500K EU Driver	1	354,00 \$

Karpat T5 IP65 Yüksek Tavan Armatürü



HID lambalara göre
daha yüksek enerji tasarrufu

IP 65

axbxcmm
2x54W:1210x190x82
4x54W:1210x345x82
2x80W:1510x190x82
4x80W:1510x345x82

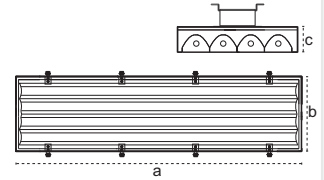

IP 65

Kod No	Özellikler	Koli Adedi	Fiyat
100778	2X54W T5	1	83,25 \$
100790	4X54W T5	1	144,75 \$
101262	2X80W T5	1	102,75 \$
101282	4X80W T5	1	181,25 \$

Busbar Askı Takımı

Hima, Etna, Karpat ve Oriza yüksek tavan armatürlerininher varyasyonu için uygundur.



axbmm
Busbar 35x55
Busbar 23x45
Busbar 28x62

- Busbar askı takımı opsiyonu

Kod No	Özellikler	Koli Adedi	Fiyat
307494	Busbar Askı Takımı	1	8,50 \$
307509	Busbar Askı Takımı	1	8,50 \$
307510	Busbar Askı Takımı	1	8,50 \$

Oriza IP65 Yüksek Tavan Armatürü

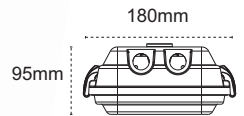

IP 65 Busbar askı takımı opsiyonu

Kod No	Özellikler	Koli Adedi	Fiyat
103457	2X54W T5 Elek. Bal. 1285mm	1	77,40 \$
103460	2X80W T5 Elek. Bal. 1595mm	1	94,30 \$
105716	82W LED 6500K 1285mm	1	114,00 \$

Gediz



Øaxbmm
160W 420x260x175
250W 420x310x175
500W 500x322x143

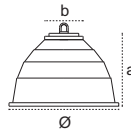

IP 65/20

Kod No	Özellikler	Koli Adedi	Fiyat
104128	Gediz 160W E27 Alm. Atölye Arm Boş.	10	20,00 \$
311067	Q402mm Cam+Conta+Klips	10	10,90 \$
311144	Q420mm Tel Kafes	1	8,00 \$

Fırat

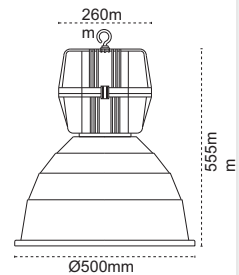

IP 65/20

Kod No	Özellikler	Koli Adedi	Fiyat
104142	Fırat 250W E40 MH/SB Poly. Atölye Arm.	4	73,50 \$
104149	Fırat 400W E40 MH Poly. Atölye Arm.	4	81,50 \$
104153	Fırat 400W E40 SB Poly. Atölye Arm.	4	89,50 \$
311068	Atölye Camı (482X4mm) + Conta ve Mandal	1	13,10 \$
311145	400W Atölye Tel Kafes	1	10,50 \$

ATEX Belgeli

- **Gaz Patlama Koruması: Zone 2**
● II 3G Ex nR IIC T5 Gc
- **Toz Patlama Koruması: Zone 22**
● II 3D Ex tc IIIC (T95 C) Dc
- **Standartlar**
EN 60079-0: 2012, EN 60079-15: 2010, EN 60079-31:2009
- **Sertifika Numarası**
IEP 16 ATEX 0468
- **Zone Sınıfı**
Zone 2
Zone 22

Ex-Proof armatürler, tehlikeli gaz ve toz maddelerinin bulunduğu, patlama riski olan ortamlarda kullanılan armatürlerdir.



Kimya ve Boya Tesisleri, Petrol Depolama Tesisleri, Petrol Dolum Boşaltım Tesisleri, Liman & Tersaneler, Enerji Santralleri, Endüstriyel Tesisler ve Akaryakıt İstasyonlarında **Güvenle Kullanabilirsiniz!**

Piroliz – Ex-Proof IP66 LED Kanopi Armatür



- **Gaz Patlama Koruması:**  II 3G Ex nR IIC T5 Gc
- **Toz Patlama Koruması:**  II 3D Ex tc IIIC (T95 C) Dc

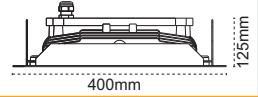

IP 66

Kod No	Özellikler	Koli Adedi	Fiyat
106578	Piroliz Ex 50W 6500K	1	686,00 \$
106579	Piroliz Ex 75W 6500K	1	775,00 \$
106580	Piroliz Ex 100W 6500K	1	864,00 \$
106581	Piroliz Ex 125W 6500K	1	954,00 \$
106582	Piroliz Ex 150W 6500K	1	1.043,00 \$

Piroliz IP65 LED Kanopi Armatür

- 100 lümen /W 'a varan verimlilik
- Alüminyum gövde
- Temperli cam



Opsiyonlar

- 1-10V dim
- 2-Step dim
- Farklı açılarda lens uygulama

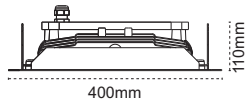

IP 65

Kod No	Özellikler	Koli Adedi	Fiyat
106583	75W 6500K	1	270,30 \$
106584	100W 6500K	1	312,70 \$
106585	125W 6500K	1	360,40 \$

Okta IP65 LED Kanopi Armatür

- 100 lümen /W 'a varan verimlilik
- Alüminyum gövde
- Temperli cam



Opsiyonlar

- DALI, 1-10V dim opsiyonu
- Siyah, beyaz ve gri renk opsiyonu

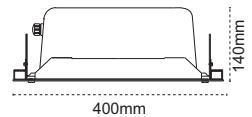

IP 65

Kod No	Özellikler	Koli Adedi	Fiyat
106627	Okta LED 80W 6500K	1	210,90 \$

ATEX Belgeli Ex-Proof Etanj

- Gaz Patlama Koruması: Zone 2
● II 3G Ex nR IIC T6 Gc

- Toz Patlama Koruması: Zone 22
● II 3D Ex tc IIIC (T80 C) Dc

- Standartlar
EN 60079-0: 2013, EN 60079-15: 2010, EN 60079-31:2014

- Sertifika Numarası
IEP 16 ATEX 0597
- Zone Sınıfı
Zone 2
Zone 22

Ex-Proof armatürler, tehlikeli gaz ve toz maddelerinin bulunduğu, patlama riski olan ortamlarda kullanılan armatürlerdir.

Kimya ve Boya Tesisleri, Petrol Depolama Tesisleri, Petrol Dolum Boşaltım Tesisleri, Liman & Tersaneler, Enerji Santralleri, Endüstriyel Tesisler ve Akaryakıt İstasyonlarında **Güvenle Kullanabilirsiniz!**

Largo – Ex-Proof IP65 Etanj Armatür

- Gaz Patlama Koruması:  II 3G Ex nR IIC T6 Gc
- Toz Patlama Koruması:  II 3D Ex tc IIIC (T80 C) Dc

Yeni
Ürün



IP 65

Kod No	Özellikler	Koli Adedi	Fiyat
108297	Largo Ex 2x18W	Şeffaf	1 131,00 \$
108298	Largo Ex 2x36W	Şeffaf	1 154,00 \$
108458	Largo Ex 25W 60cm	Opal 6500K	1 240,00 \$
108459	Largo Ex 45W 120cm	Opal 6500K	1 258,00 \$

Sia – Ex-Proof IP66 LED Yüksek Tavan Armatürü

- Gaz Patlama Koruması:  II 3G Ex nR IIC T5 Gc
- Toz Patlama Koruması:  II 3D Ex tc IIIC (T95 C) Dc

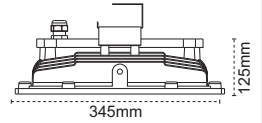

IP 66

Kod No	Özellikler	Koli Adedi	Fiyat
106615	Sia Ex 50W 6500K	1	686,00 \$
106616	Sia Ex 75W 6500K	1	775,00 \$
106617	Sia Ex 100W 6500K	1	864,00 \$
106618	Sia Ex 125W 6500K	1	954,00 \$
106619	Sia Ex 150W 6500K	1	1.043,00 \$

Nairo – Ex-Proof IP66 LED Projektör

- Gaz Patlama Koruması:  II 3G Ex nR IIC T5 Gc
- Toz Patlama Koruması:  II 3D Ex tc IIIC (T95 C) Dc

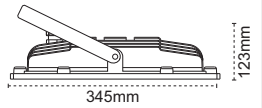

IP 66

Kod No	Özellikler	Koli Adedi	Fiyat
106498	Nairo Ex 50W 6500K	1	686,00 \$
106499	Nairo Ex 75W 6500K	1	775,00 \$
106500	Nairo Ex 100W 6500K	1	864,00 \$
106501	Nairo Ex 125W 6500K	1	954,00 \$
106502	Nairo Ex 150W 6500K	1	1.043,00 \$

Ria LED



Otomatik Gece Modu ile Daha Fazla Tasarruf!

- 100lm/W'ın üzerinde verimlilik
- Avrupa LED Çip
- Simetrik ve asimetrik ışık dağılımı
- 50.000 saat ömür
- Açı ayarlanabilir konsol



★ Gece Modu
★ Opsiyonlu

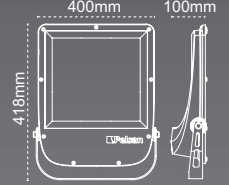

Ria IP66 LED Projektör, müşterilerimizin isteğine göre kendini gecenin belirli bir saatinden sonra dimleyebilir. Bu özelliği ile LED'in sağladığı tasarrufa ekstra bir tasarruf sağlayarak enerji sarfiyatını minimuma düşürür.

Ria IP66 Power



IP 66

Kod No	Özellikler	Koli Adedi	Fiyat
107121	100W Simetrik 6500K	1	236,00 \$
107124	150W Simetrik 6500K	1	257,00 \$

Ria IP66 Power



IP 66

Kod No	Özellikler	Koli Adedi	Fiyat
107132	100W Simetrik 6500K	1	260,00 \$
107134	125W Simetrik 6500K	1	275,00 \$
107136	150W Simetrik 6500K	1	292,00 \$

★ Gece Modu
★ Opsiyonlu



Ria IP66 Simetrik



IP 66

Kod No	Özellikler	Koli Adedi	Fiyat
107140	180W Simetrik 6500K	1	368,00 \$
107141	200W Simetrik 6500K	1	403,00 \$
107130	240W Simetrik 6500K	1	486,00 \$



Ria IP66 Asimetrik



IP 66

Kod No	Özellikler	Koli Adedi	Fiyat
107137	180W Asimetrik 6500K	1	368,00 \$
107138	200W Asimetrik 6500K	1	403,00 \$
107127	240W Asimetrik 6500K	1	486,00 \$



Ria IP66 Power Lux

- Avrupa Driver



IP 66

Kod No	Özellikler	Koli Adedi	Fiyat
106495	140W Simetrik 6500K	1	439,00 \$

Ria IP66 Power Lux

- Avrupa Driver



IP 66

Kod No	Özellikler	Koli Adedi	Fiyat
106497	215W Simetrik 6500K	1	496,50 \$

Maxled Direk Montajına Uygunur

- 110 lm/W üzerinde etkinlik faktörü
- Avrupa LED çip & LED sürücü
- 15° / 30° / 45+20° lens açısı opsiyonu
- 1-10V Dim
- Sıva üstü açılı montaj, ikili montaj, direk montajına uygundur

Opsiyonlar

- DALI Dim
- DMX kontrol



IP66

Maxled IP66



axbxcmm
300W630x345x339
500W630x515x339

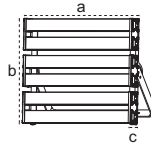

IP 66

Kod No	Özellikler	Koli Adedi	Fiyat
107142	300W 6500K	1	589,50 \$
107143	500W 6500K	1	1.044,00 \$

Inovaled Projektör

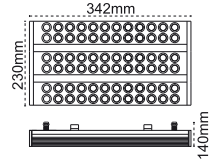

IP 65

Kod No	Özellikler	Koli Adedi	Fiyat
105557	60W 6500K	1	131,50 \$
105571	90W 6500K	1	203,50 \$

Liya

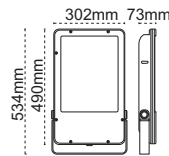

IP 65

Kod No	Özellikler	Koli Adedi	Fiyat
105933	103W Simetrik 6500K	1	373,50 \$
105937	154W Simetrik 6500K	1	411,50 \$
105940	180W Simetrik 6500K	1	471,50 \$

Nairo

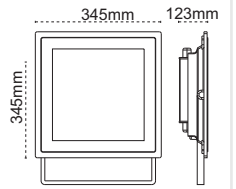

IP 65

Kod No	Özellikler	Koli Adedi	Fiyat
106504	75W 6500K	1	266,50 \$
106505	100W 6500K	1	308,50 \$
106518	125W 6500K	1	355,50 \$

Forino

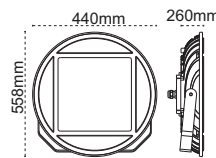

IP 65

Kod No	Özellikler	Koli Adedi	Fiyat
106568	103W 6500K	1	344,50 \$

Forino Med

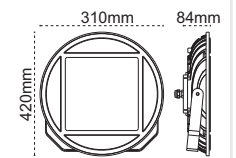

IP 65

Kod No	Özellikler	Koli Adedi	Fiyat
106574	59W 6500K	1	204,50 \$
106577	65W 6500K (Prizmatik Camli)	1	177,50 \$

Franko 100W

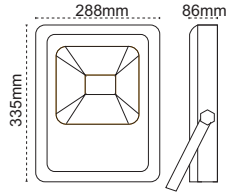

IP 65

Kod No	Özellikler	Koli Adedi	Fiyat
107105	100W 4000K	4	85,75 \$
107106	100W 6500K	4	85,75 \$

Franko 70W

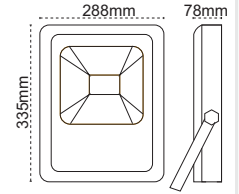

IP 65

Kod No	Özellikler	Koli Adedi	Fiyat
107103	70W 4000K	4	60,50 \$
107104	70W 6500K	4	60,50 \$

Franko 50W

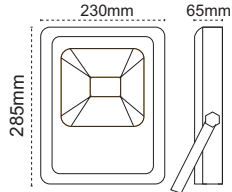

6500K

4500K

Amber

Yesil

IP 65

Kod No	Özellikler	Koli Adedi	Fiyat
107101	50W 4000K	6	39,25 \$
107102	50W 6500K	6	39,25 \$
108166	50W Amber	6	50,50 \$
108167	50W Yesil	6	50,50 \$

Franko 30W

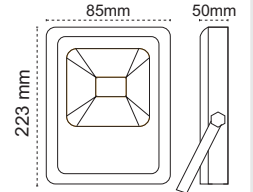

IP 65

Kod No	Özellikler	Koli Adedi	Fiyat
107100	30W 6500K	10	24,50 \$

Franko 30 Sensörlü

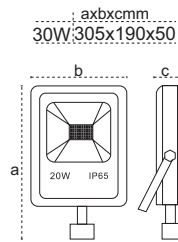

IP 65

Kod No	Özellikler	Koli Adedi	Fiyat
107118	30W Sensörlü 6500K	10	36,00 \$

Franko Projektör Ayağı



IP 65

10W, 20W, 30W ve 50 W projektör için uygundur.

Kod No	Özellikler	Koli Adedi	Fiyat
203948	Projektör Tripot	4	35,00 \$

Franko

Beyan Ettiği Güç ve Lümeni Verir!

- Ömrü boyunca aynı lümen çıktısı
- 88 lm/W'ın üzerinde etkinlik faktörü
- 30.000 saat ömür
- Alüminyum gövde
- Ayarlanabilir konsol
- Toz ve su almaz, IP65



Franko 400W

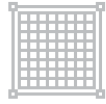

Tel Kafes Uygulaması

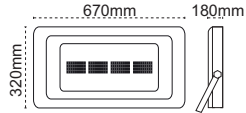

IP 65

Kod No	Özellikler	Koli Adedi	Fiyat
107117	400W 5000K	1	526,50 \$
310866	400W Tel Kafes	1	13,00 \$

Franko 300-250W



Tel Kafes Uygulaması

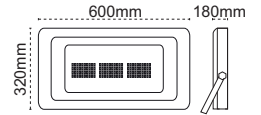

IP 65

Kod No	Özellikler	Koli Adedi	Fiyat
107115	250W 5000K	1	273,50 \$
107116	300W 5000K 4000K	1	381,50 \$
310865	250W-300W Tel Kafes	1	13,00 \$

Franko 200W

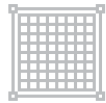

Tel Kafes Uygulaması

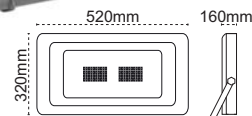

IP 65

Kod No	Özellikler	Koli Adedi	Fiyat
107112	200W 5000K	1	195,75 \$
310864	200W Tel Kafes	1	13,00 \$

Franko 150W



Tel Kafes Uygulaması

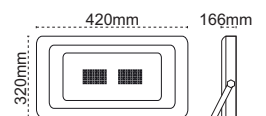

IP 65

Kod No	Özellikler	Koli Adedi	Fiyat
107109	150W 5000K	2	148,50 \$
107110	150W 5000K EU Driver	2	185,00 \$
310863	150W Tel Kafes	1	13,00 \$

**Olimpiad 1000W-400w
Simetrik
Fiberglass**

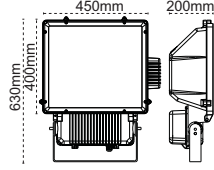

IP 65

Kod No	Özellikler	Koli Adedi	Fiyat
105137	1000W Metal, MH/SB	1	189,00 \$
105256	400W Metal MH	1	103,50 \$

**Yeno 250-400W Simetrik
Fiberglass**

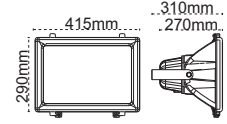

IP 65

Kod No	Özellikler	Koli Adedi	Fiyat
105161	250W MH/SB HPI-T	1	77,75 \$
105173	400W SB SON-T	2	94,00 \$
105166	400W MH HPI-T	2	81,00 \$

**Euro 1000W Simetrik
Alüminyum Enjeksiyon**

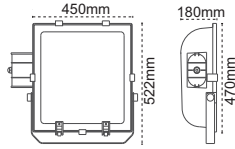

IP 65

Kod No	Özellikler	Koli Adedi	Fiyat
105216	1000 W Metal, HPI-T	1	378,00 \$

**Tünel 250-400W
Alüminyum Enjeksiyon**

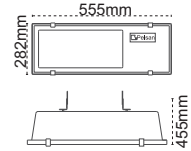

IP 65

Kod No	Özellikler	Koli Adedi	Fiyat
104327	250W MH/SB E40	1	147,00 \$
104329	400W SB E40	1	153,00 \$

**Elit Pesato 250-400W Asimetrik
Fiberglass**

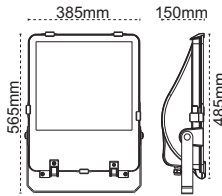

IP 65

Kod No	Özellikler	Koli Adedi	Fiyat
105187	250W MH/SB HPI-T	1	88,00 \$
105190	400W MH HPI-T	1	89,00 \$
105196	400W SB SON-T	1	94,75 \$

**Elit Lirad 70-150W Simetrik
Fiberglass**

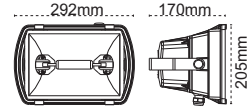

IP 65

Kod No	Özellikler	Koli Adedi	Fiyat
104320	70W MH/SB MHN-TD	6	45,75 \$
104323	150W MH/SB MHN-TD	6	50,50 \$

**Elit Semiad 70-150W Asimetrik
Fiberglass**

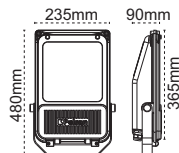

IP 65

Kod No	Özellikler	Koli Adedi	Fiyat
104308	70W MH/SB MHN-TD	4	45,75 \$
104311	150W MH/SB MHN-TD	4	50,50 \$

**Levo
Alüminyum Enjeksiyon**

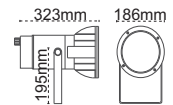

IP 65

Kod No	Özellikler	Koli Adedi	Fiyat
104300	70W Metal CDM-T	4	58,75 \$
104301	150W Metal CDM-T	4	62,75 \$
107758	Levo LED 25W 6500K	4	108,00 \$

Uzun Ömürlü, Yüksek Verimli Pelsan IP66 Wallwasher

- Çevre şartlarından etkilenmeyen IP66 alüminyum gövde
- Darbe dayanıklı, UV katkılı su geçirmez difüzör
- Ömrü boyunca sararma yapmayan PMMA Avrupa lens
- Avrupa LED çip
- Pelsan sabit akım driver
- Nem oluşumunu engelleyerek komponent ömrünü uzatan hava ventilli rakor



Işık Hüzmesi

15°

30°

45°+20°

Ekstra Açısı ile
Homojen Işık Dağılımı

Hem kolon hem duvar aydınlatması

S.Ü. Wallwasher IP66 Inoaled 30 cm 12 LEDli



Renk	Fiyat
Mavi	+7,35 \$
Yeşil	+7,35 \$
Kırmızı	+7,35 \$
Amber	+7,35 \$
RGB	+56,60 \$

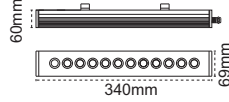

IP 66

Kod No	Özellikler	Koli Adedi	Fiyat
105463	15W 15 Derece 6500K	1	52,00 \$
105486	15W 30 Derece 6500K	1	52,00 \$
105509	15W 45+20 Derece 6500K	1	52,00 \$
105536	Çift Modül 30W 24 LEDli 6500K	1	65,50 \$

S.Ü. Wallwasher IP66 Inoaled 60 cm 24 LEDli



Renk	Fiyat
Mavi	+14,70\$
Yeşil	+14,70\$
Kırmızı	+14,70\$
Amber	+14,70\$
RGB	+64,90\$

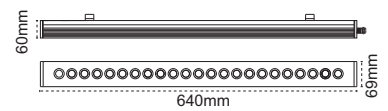

IP 66

Kod No	Özellikler	Koli Adedi	Fiyat
105470	30W 15 Derece 6500K	1	83,00 \$
105493	30W 30 Derece 6500K	1	83,00 \$
105518	30W 45+20 Derece 6500K	1	83,00 \$
105543	Çift Modül 60W 48 LEDli 6500K	1	120,25 \$

S.Ü. Wallwasher IP66 Inoaled 90 cm 36 LEDli



Renk	Fiyat
Mavi	+22,00 \$
Yeşil	+22,00 \$
Kırmızı	+22,00 \$
Amber	+22,00 \$
RGB	+88,90 \$

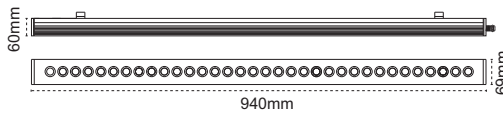

IP 66

Kod No	Özellikler	Koli Adedi	Fiyat
105478	45W 15 Derece 6500K	1	124,75 \$
105501	45W 30 Derece 6500K	1	124,75 \$
105526	45W 45+20 Derece 6500K	1	124,75 \$
105550	Çift Modül 90W 72 LEDli 6500K	1	153,50 \$

S.Ü. Wallwasher IP66 Inoaled 120 cm 48 LEDli



Renk	Fiyat
Mavi	+29,40 \$
Yeşil	+29,40 \$
Kırmızı	+29,40 \$
Amber	+29,40 \$
RGB	+112,90 \$

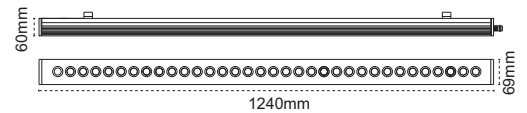

IP 66

Kod No	Özellikler	Koli Adedi	Fiyat
108112	45W 45+20 Derece 6500K	1	143,25 \$

Yeni
Ürün

Talin

4 Farklı Güç, 4 Farklı Boyut Şimdi Daha Hesaplı!

- Alüminyum enjeksiyon gövde
- Toz ve su almaz, IP65
- Darbelere dayanıklı IK08

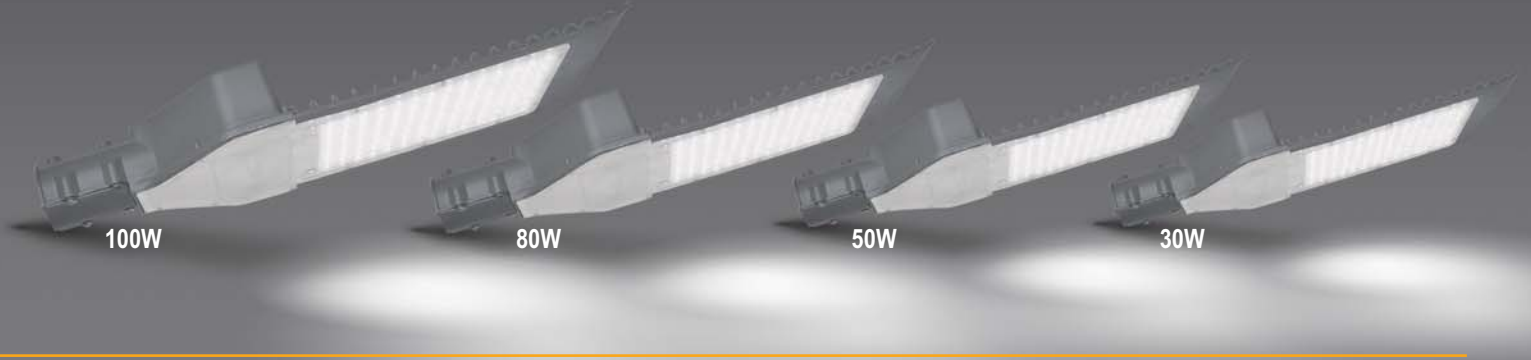

Talin

Yeni
Ürün



axbxc mm Ø
30W:355x125x55:42
50W:405x165x55:42
80W:505x190x75:60
100W:620x220x75:60

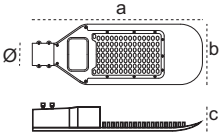

IP 65

Kod No	Özellikler	Koli Adedi	Fiyat
107992	30W 4000K	15	55,75 \$
107993	50W 4000K	10	77,75 \$
108438	80W 4000K	4	128,25 \$
107994	100W 4000K	4	167,00 \$

Bari

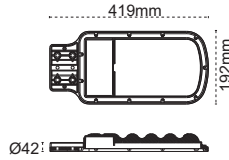

IP 65

Kod No	Özellikler	Koli Adedi	Fiyat
105777	42W 4000K	2	102,00 \$

Lizbon

Yeni
Ürün

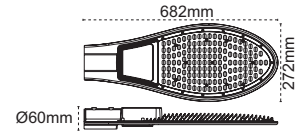

IP 65

Kod No	Özellikler	Koli Adedi	Fiyat
107906	150W 4000K	2	238,50 \$

Lima

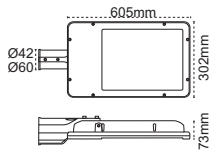

IP 65

Kod No	Özellikler	Koli Adedi	Fiyat
105957	103W 4000K	1	394,00 \$
105961	154W 4000K	1	453,00 \$
105967	180W 4000K	1	514,00 \$

Tokyo / Tokyo MED

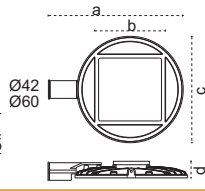

axbxcxdmm
Tokyo:558x260x440x92
Tokyo MED:442x310x310x115

IP 65

Kod No	Özellikler	Koli Adedi	Fiyat
106526	77W 4000K	1	295,00 \$
106531	103W 4000K	1	374,00 \$
106537	39W 4000K Med	1	196,50 \$
106543	59W 4000K Med	1	206,00 \$

Seul LED

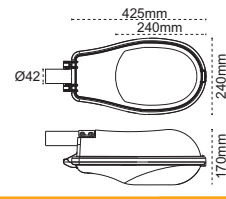

IP 65

Kod No	Özellikler	Koli Adedi	Fiyat
105979	30W 4000K	10	78,00 \$

Rio

TEDAŞ
Şartnamelerine
Uygun



M1 - M2 - M3 - M4 - M5 yol sınıflarına uygun.

Otomatik dim programlama opsiyonu ile ayarlanabilir ışık seviyesi

- Avrupa LED çip ve Avrupa driver
- +120 lm/W Etkinlik Faktörü
- 45W'dan 240W'a kadar güç seçeneği
- 0° - 5° - 10° - 15° ayarlanabilir konsol
- -40 / +50 °C ortam koşulunda çalışır
- Toz ve su almaz, IP66
- Darbelere dayanıklı IK09

Rio Plus IP66 Avrupa Driver

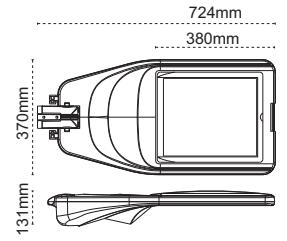

IP 66

Kod No	Özellikler	Koli Adedi	Fiyat
106694	200W 4000K	1	577,00 \$
106682	240W 4000K	1	627,00 \$

Rio Plus IP66 Avrupa Driver

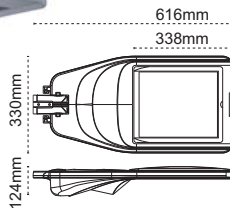

IP 66

Kod No	Özellikler	Koli Adedi	Fiyat
106687	100W 4000K	1	385,00 \$
106685	140W 4000K	1	446,00 \$

Rio IP66

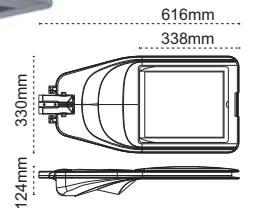

IP 66

Kod No	Özellikler	Koli Adedi	Fiyat
107770	100W 4000K	1	280,00 \$
108012	150W 4000K	1	349,00 \$

Rio Plus IP66 Avrupa Driver

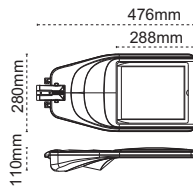

IP 66

Kod No	Özellikler	Koli Adedi	Fiyat
106671	45W 4000K	1	242,00 \$
106674	65W 4000K	1	268,00 \$

Rio IP66

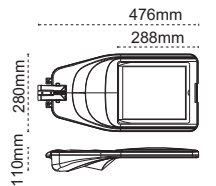

IP 66

Kod No	Özellikler	Koli Adedi	Fiyat
108160	50W 4000K	1	194,00 \$
108159	70W 4000K	1	213,00 \$
108079	100W 4000K	1	230,00 \$

Roma

TEDAŞ
Şartnamelerine
Uygun



- Toz ve su almaz, **IP66**
- Polimer enjeksiyon gövde
- Darbelere dayanıklı IK08 koruma sınıfına sahip temperli cam
- 42 – 60 mm çaplı alttan veya yandan montaja uygun giriş konsolu
- Isıl anahtarlı, bakır sargılı balast
- Gün ışığına duyarlı fotosel uygulaması

Roma Polimer Enjeksiyon

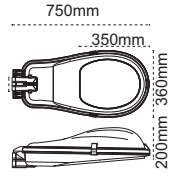

IP 66

Kod No	Özellikler	Koli Adedi	Fiyat
104102	250W SB SON-T	1	101,00 \$
104105	400W SB SON-T	1	112,25 \$

Sofia Polimer Enjeksiyon

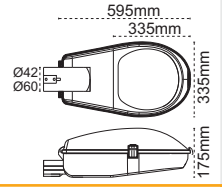

IP 65

Kod No	Özellikler	Koli Adedi	Fiyat
104077	Sofia 100 W Sodyum SON-T	2	60,50 \$
104081	Sofia 150 W Sodyum SON-T	2	65,25 \$

Riga Polimer Enjeksiyon

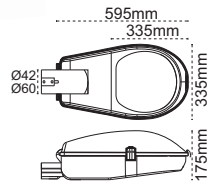

IP 65

Kod No	Özellikler	Koli Adedi	Fiyat
104062	Riga 50 W Sodyum SON-T	2	51,00 \$
104064	Riga 70 W Sodyum SON-T	2	55,25 \$

Seul Polimer Enjeksiyon

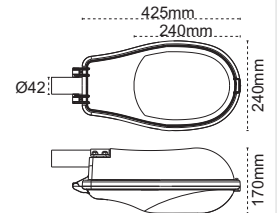

IP 65

Kod No	Özellikler	Koli Adedi	Fiyat
104111	65W Boş PLE	5	17,50 \$

Lyon Alüminyum Enjeksiyon

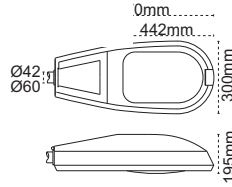

IP 65 / 43

Kod No	Özellikler	Koli Adedi	Fiyat
103991	100 W Sodyum SON-T	1	156,50 \$
103992	150 W Sodyum SON-T	1	161,25 \$
103998	250 W Sodyum SON-T	1	180,75 \$
104007	400 W Sodyum SON-T	1	185,50 \$

Bakü Temperli Camlı Alüminyum

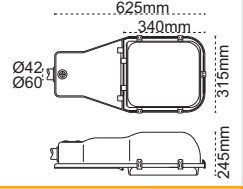

IP 65 / 43

Kod No	Özellikler	Koli Adedi	Fiyat
103874	150W Sodyum SON-T	1	87,50 \$
103877	250W Sodyum SON-T	1	96,00 \$
103881	400W Sodyum SON-T	1	100,25 \$

Parma Alüminyum

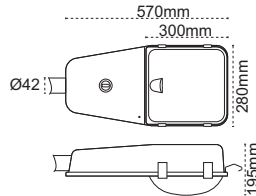

IP 54 / 43

Kod No	Özellikler	Koli Adedi	Fiyat
103790	160W Boş E27	5	43,00 \$
103796	150W Sodyum SON-T	5	78,25 \$

Ibiza Fiberglass

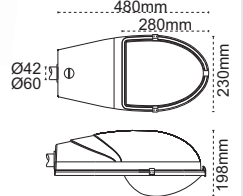

IP 54 / 43

Kod No	Özellikler	Koli Adedi	Fiyat
103952	85 W Boş E27	5	20,75 \$
103946	160 W Boş E27	5	20,75 \$
103958	70 W Son-T	5	43,00 \$

Corfu Fiberglass

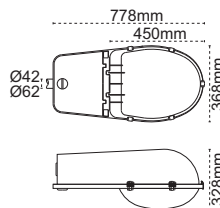

IP 54 / 43

Kod No	Özellikler	Koli Adedi	Fiyat
103823	250W Boş E40	1	48,25 \$
103831	250W Sodyum SON-T	1	81,00 \$
103842	400W Sodyum SON-T	1	92,50 \$

Konsollar

IP 40

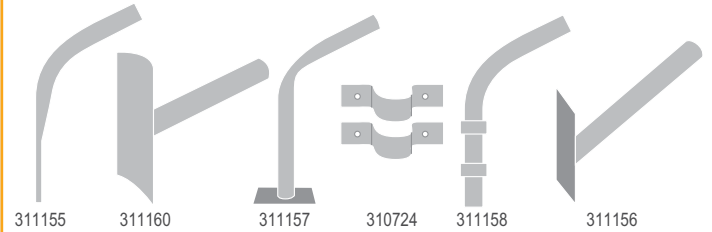

Kod No	Özellikler	Koli Adedi	Fiyat
311156	Ø60 Direk Tipi Konsol Boru	1	8,50 \$
311151	Set Üstü Konsol 60cm	1	4,65 \$
311158	Duvar Tipi Konsol Boru 30cm Ø42	1	7,00 \$
311160	Konsol Boru 60cm	25	8,50 \$
311157	Duvar Tipi Konsol Boru 60cm Ø42	25	8,50 \$
311155	Kelepçeli Konsol	1	7,00 \$
301125	60/42 Konsol Adaptörü	1	9,00 \$
310724	Boru Kelepçe	1	1,85 \$

Soho

Park Bahçe Yönetmeliğine Uygun

- Gece 2'den sonra otomatik %50 dim opsiyonu
- Avrupa LED Çip , Avrupa driver
- Modüler tasarım

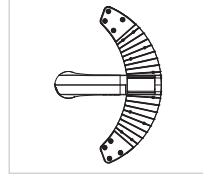

Soho 1
Tekli Modül Montaj

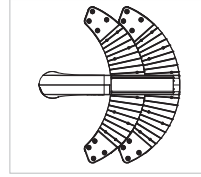

Soho 2
İkili Modül Montaj

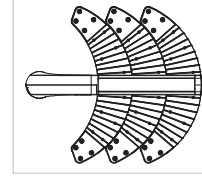

Soho 3
Üçlü Modül Montaj

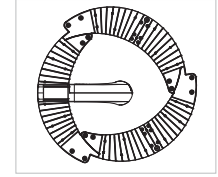

Soho 4
Üçlü Modül Montaj

IP Sınıfı	IP65
Gövde	Alüminyum
Önerilen Uygulama Yüksekliği	4 - 6 m
LED Çip	Avrupa LED Çip
LED Driver	Avrupa Driver
Konsol Çapı	76 mm

Zaman Ayarı Opsiyonu

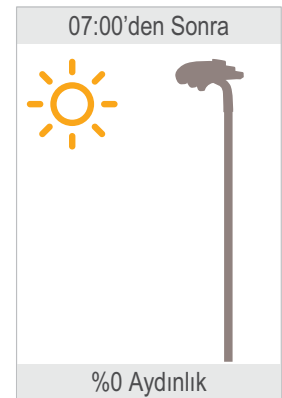
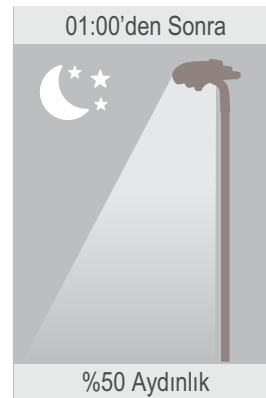

Soho

IP 65

Kod No	Özellikler	Koli Adedi	Fiyat
107512	Soho 1 25W LED 6500K 4m direkli	1	608,00 \$
107513	Soho 2 50W LED 6500K 4m direkli	1	666,00 \$
107514	Soho 3 75W LED 6500K 4m direkli	1	729,00 \$
107516	Soho 4 75W LED 6500K 4m direkli	1	699,00 \$

Olimpos R

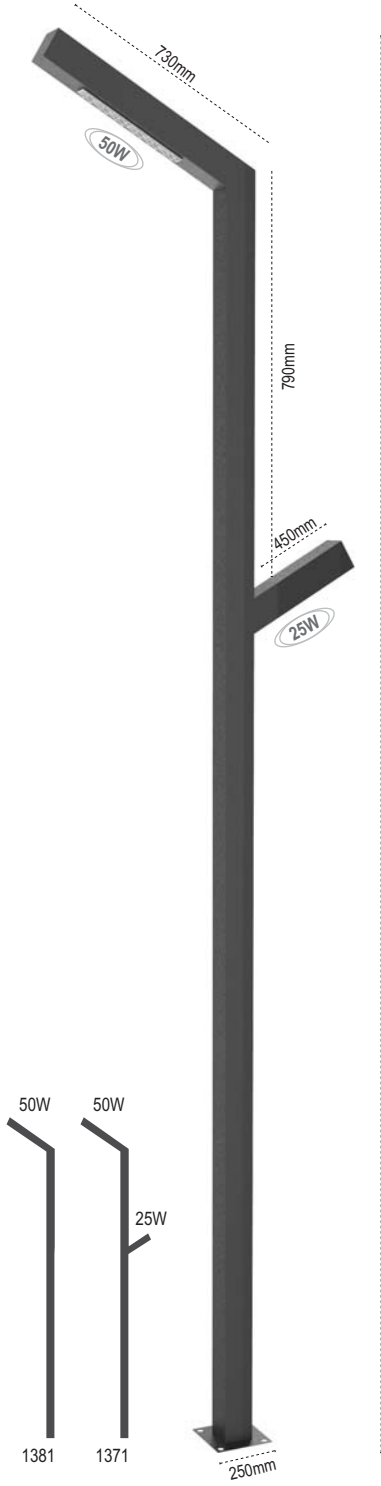

Size özel Olimpos tasarımlar için satış temsilcimize danışınız.

IP 65

Kod No	Özellikler	Koli Adedi	Fiyat
107501	75W 4000K	1	808,00 \$
107509	50W 4000K	1	744,00 \$

Olimpos T

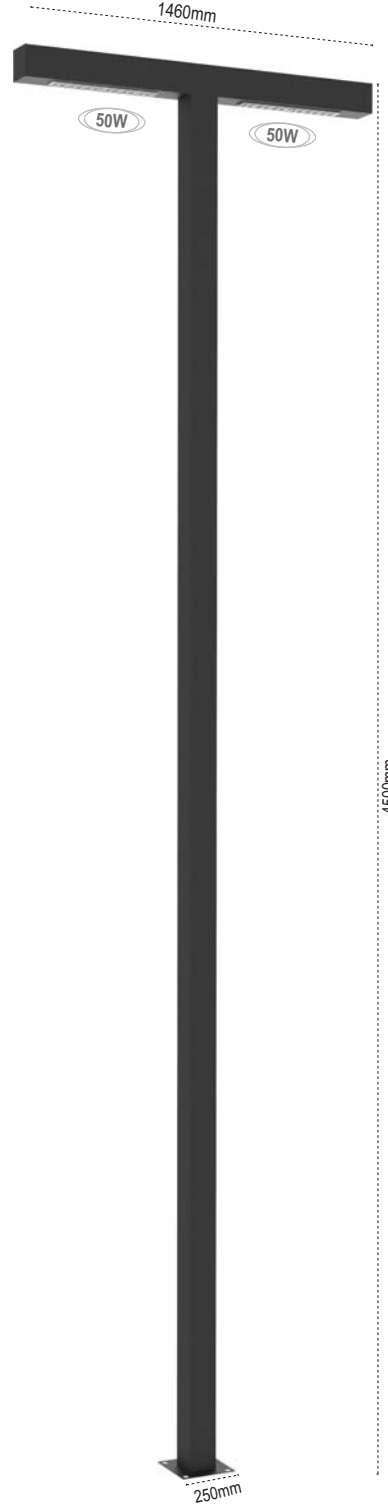

Size özel Olimpos tasarımlar için satış temsilcimize danışınız.

IP 65

Kod No	Özellikler	Koli Adedi	Fiyat
108498	100W 4000K	1	872,00 \$

Olimpos T

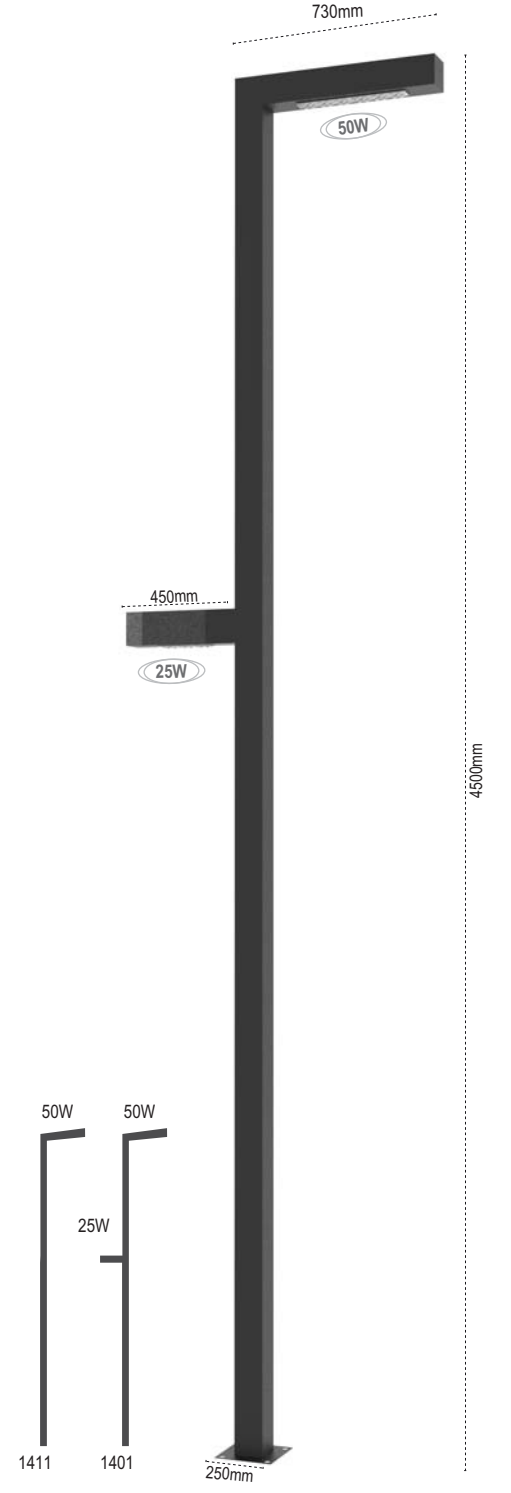

Size özel Olimpos tasarımlar için satış temsilcimize danışınız.

IP 65

Kod No	Özellikler	Koli Adedi	Fiyat
108499	75W 4000K	1	808,00 \$
108261	50W 4000K	1	744,00 \$

Evaled

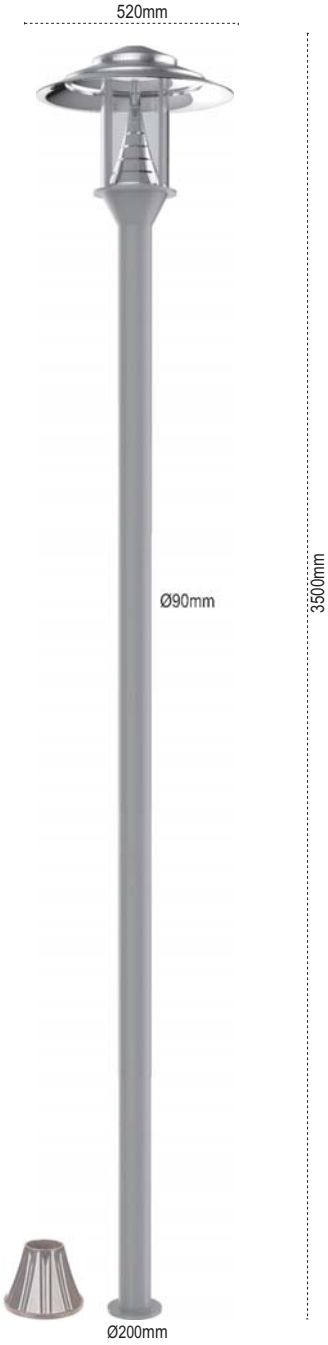

IP 54

Kod No	Özellikler	Koli Adedi	Fiyat
108610	40W 4000K	1	378,00 \$

Mesaled

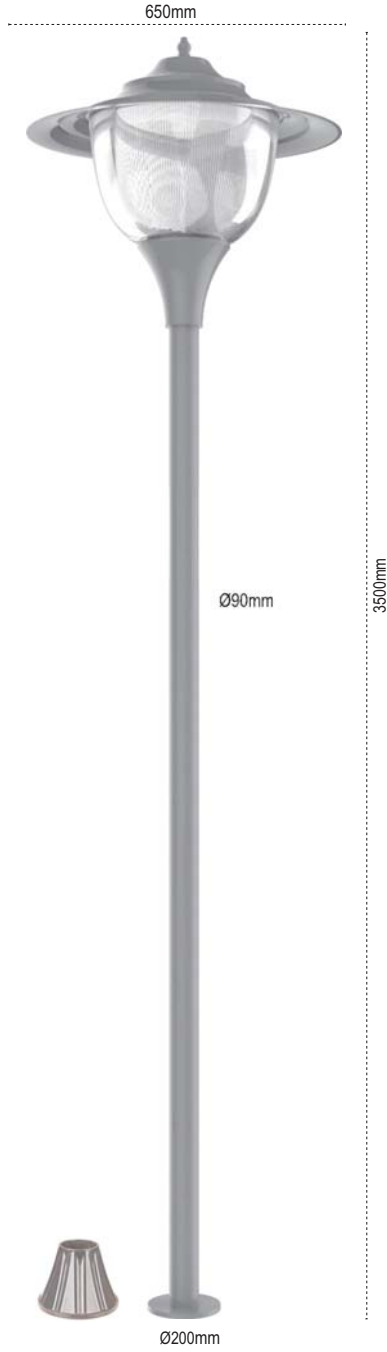

IP 54

Kod No	Özellikler	Koli Adedi	Fiyat
108609	30W 4000K	1	303,00 \$
108608	60W 4000K	1	326,00 \$

Datça

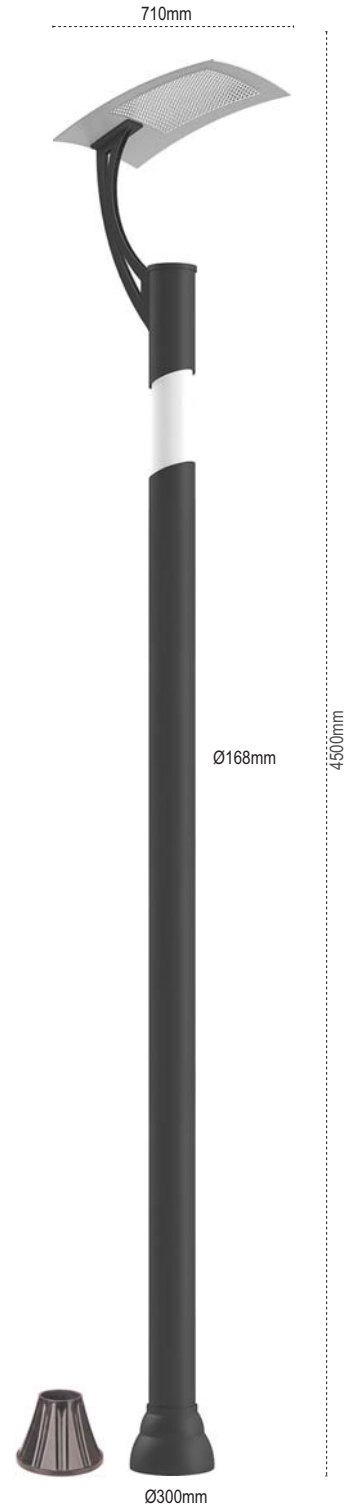

IP 65

Kod No	Özellikler	Koli Adedi	Fiyat
107619	150W G12	1	528,00 \$
107601	30W 4000K	1	719,00 \$
313768	RGB Kontrol Cihazı	1	22,00 \$

LEDli Park Bahçe Aydınlatma Armatürleri

Limra LED

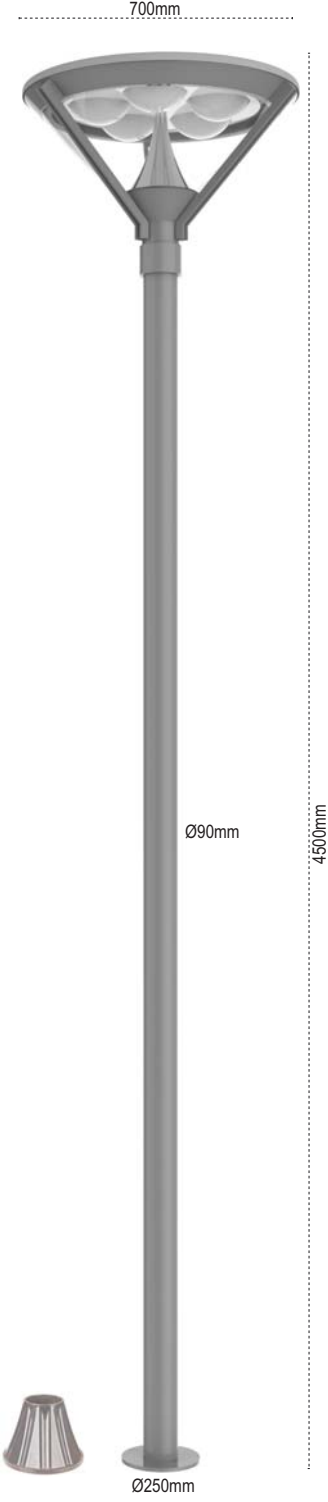

IP 54 ⊕

Kod No	Özellikler	Koli Adedi	Fiyat
107416	150W E40	1	439,00 \$
108606	38W 3 4000K	1	562,00 \$
108605	80W 5 4000K	1	657,00 \$

Patras LED

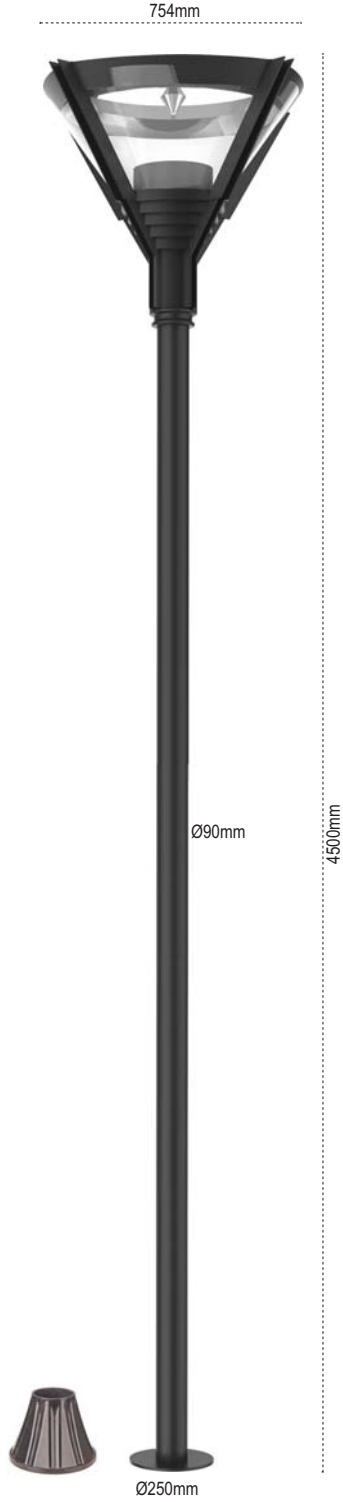

IP 65 ⊕

Kod No	Özellikler	Koli Adedi	Fiyat
107661	150W Rx7S	1	657,00 \$
105989	68W 4000K	1	695,00 \$

Verde LED

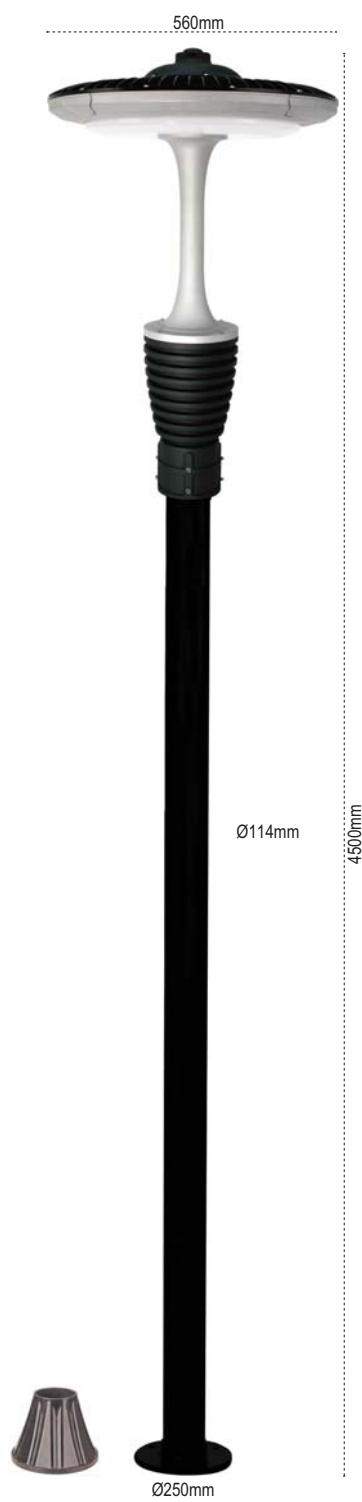

IP 65 ⊕

Kod No	Özellikler	Koli Adedi	Fiyat
106668	68W 4000K	1	705,00 \$

Samos LED

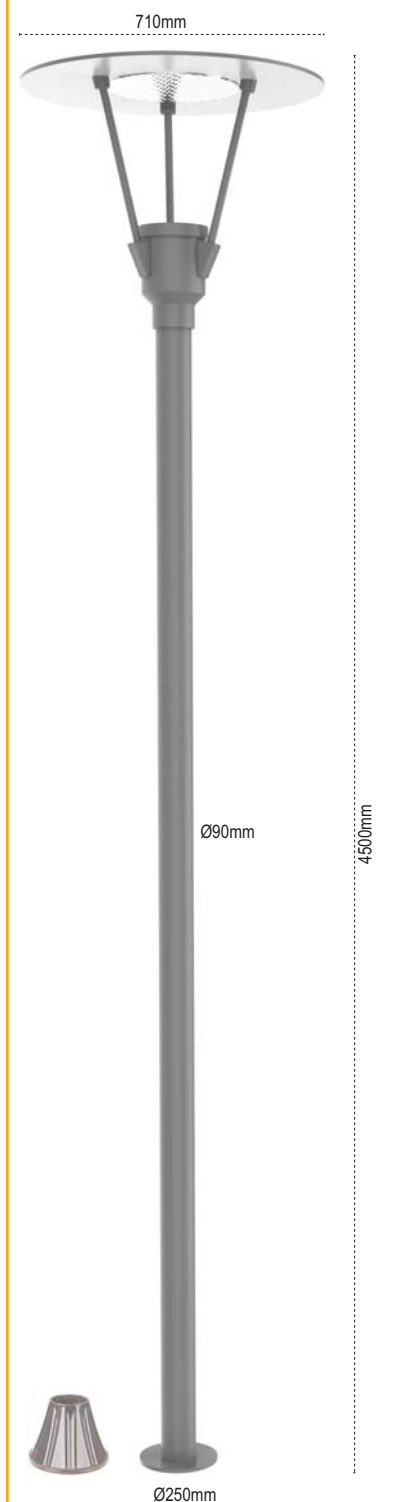

IP 65 ⊕

Kod No	Özellikler	Koli Adedi	Fiyat
108612	150W G12	1	483,00 \$
108163	50W 4000K	1	566,00 \$

Pelsan LEDli Park Bahçe Aydınlatma Armatürleri

Assos

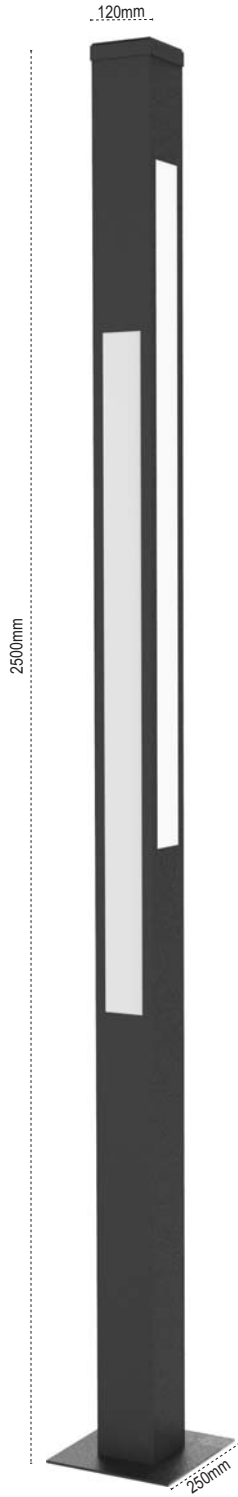

IP 65

Kod No	Özellikler	Koli Adedi	Fiyat
107470	100W 4000K	1	696,00 \$

Milas

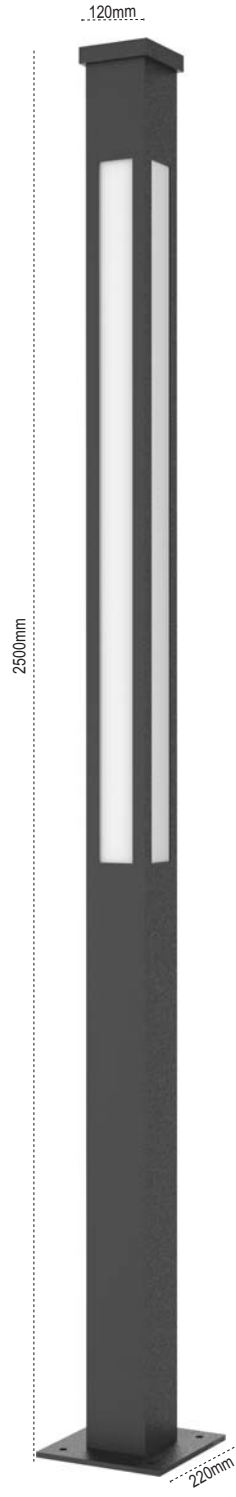

IP 65

Kod No	Özellikler	Koli Adedi	Fiyat
108500	100W 4000K	1	610,00 \$

Patara



IP 65

Kod No	Özellikler	Koli Adedi	Fiyat
107488	125W 4000K	1	695,00 \$

LEDli Park Bahçe Aydınlatma Armatürleri

Milet

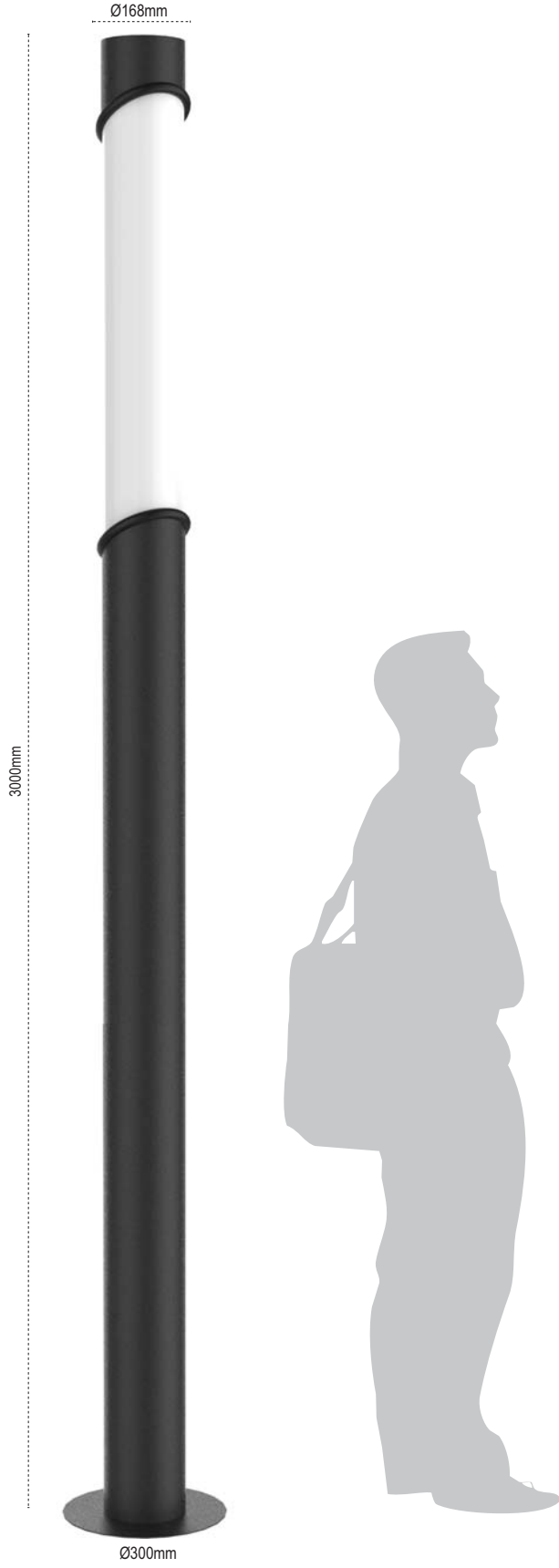

IP 65

Kod No	Özellikler	Koli Adedi	Fiyat
108501	40W 4000K	1	508,00 \$

Bitez



IP 65

Kod No	Özellikler	Koli Adedi	Fiyat
105760	100W 4000K	1	439,00 \$

Eva

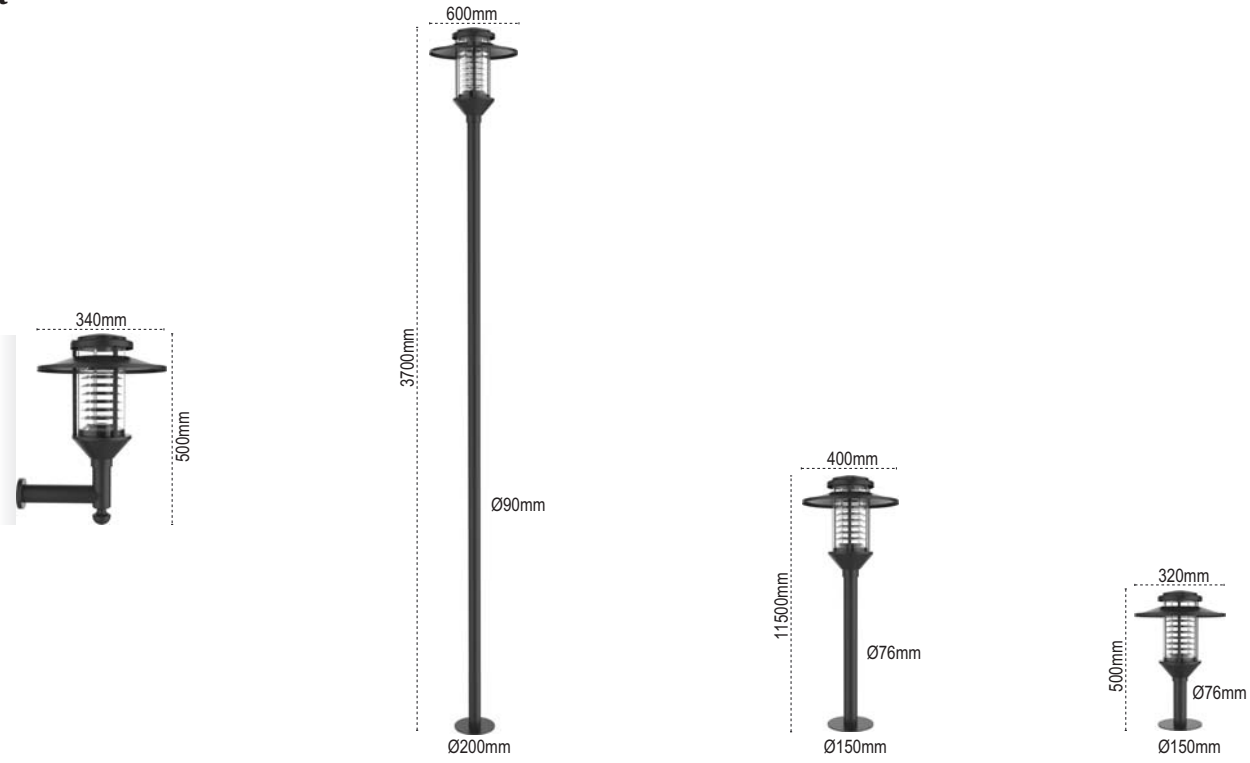

IP 54

Kod No	Özellikler	Koli Adedi	Fiyat
107520	Eva Boru Direk Arm. E27	1	217,00 \$
107560	Eva Çimen Arm. E27	1	124,00 \$
107453	Eva Set Üstü E27	1	124,00 \$
107411	Eva Aplik E27	1	124,00 \$

Temi

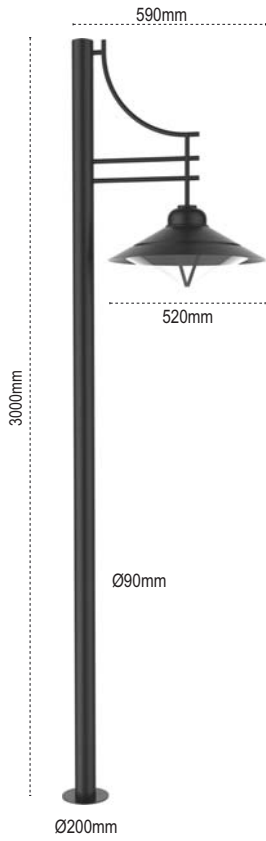

IP 54

Kod No	Özellikler	Koli Adedi	Fiyat
107519	Temi Direk E27	1	127,00 \$

Karo



IP 54

Kod No	Özellikler	Koli Adedi	Fiyat
204491	Karo Fener Aplik E27	10	14,50 \$
204634	Karo Fener Set Üstü E27	10	14,50 \$

Perge

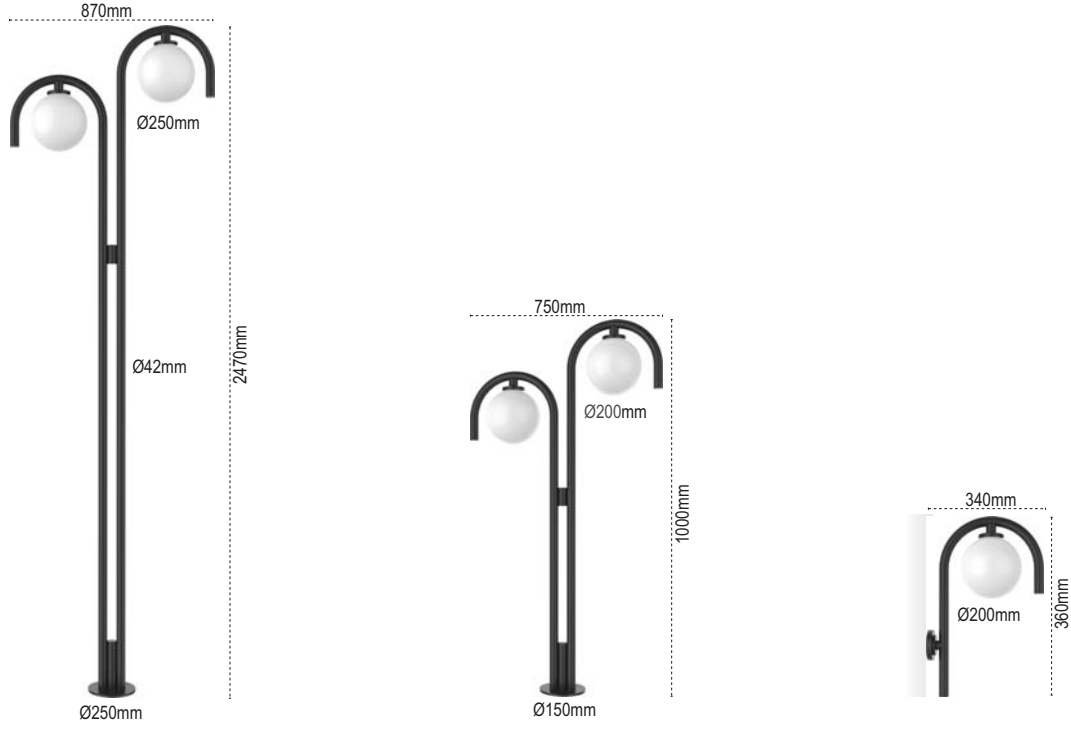

IP 54

Kod No	Özellikler	Koli Adedi	Fiyat
107543	Perge Direk Arm. E27	1	147,00 \$
107585	Perge Çimen Arm. E27	1	67,50 \$
107391	Perge Aplik E27	1	67,50 \$

Uruse

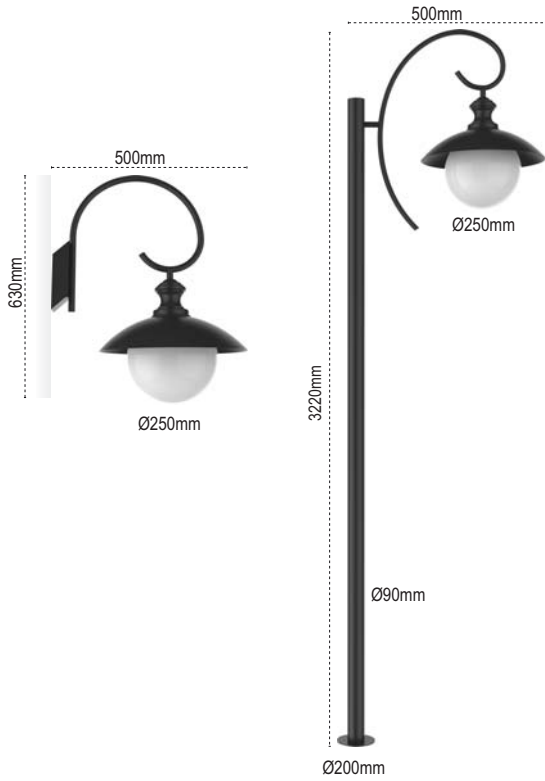

IP 54

Kod No	Özellikler	Koli Adedi	Fiyat
107510	Uruse Boru Direk E27	1	140,00 \$
107395	Uruse Duvar Aplik E27	1	74,00 \$

Pedesa

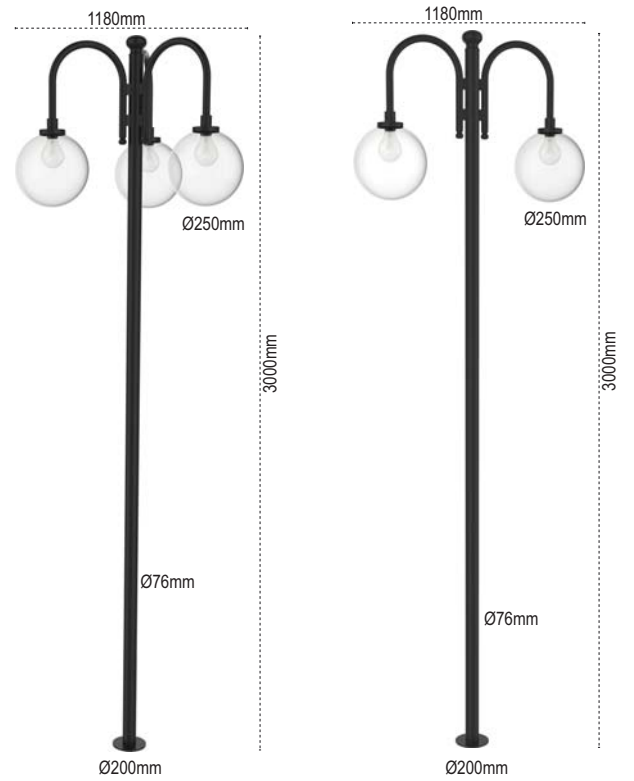

IP 54

Kod No	Özellikler	Koli Adedi	Fiyat
107533	Pedesa Şeffaf 1 Gloplu Direk E27	1	107,00 \$
107517	Pedesa Şeffaf 2 Gloplu Direk E27	1	178,00 \$
107530	Pedesa Şeffaf 3 Gloplu Direk E27	1	253,00 \$

Pelsan Takım Park Bahçe Armatürleri

Antalya (Alüminyum)

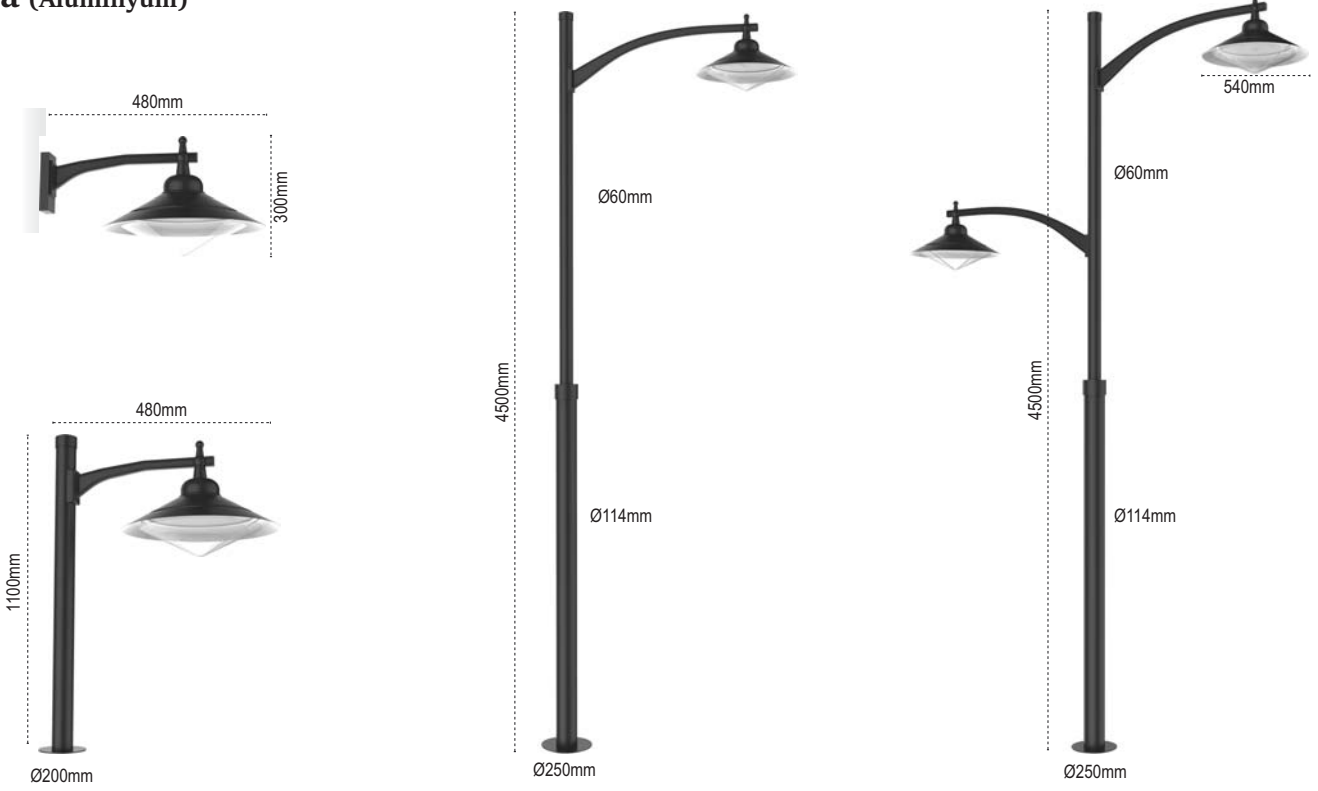

IP 54

Kod No	Özellikler	Koli Adedi	Fiyat
107531	Antalya 1'li Direk E27	1	205,00 \$
107532	Antalya 2'li Direk E27	1	261,00 \$
107588	Antalya Çimen Arm. E27	1	115,00 \$
107409	Antalya Aplik E27	1	85,00 \$

Ruso

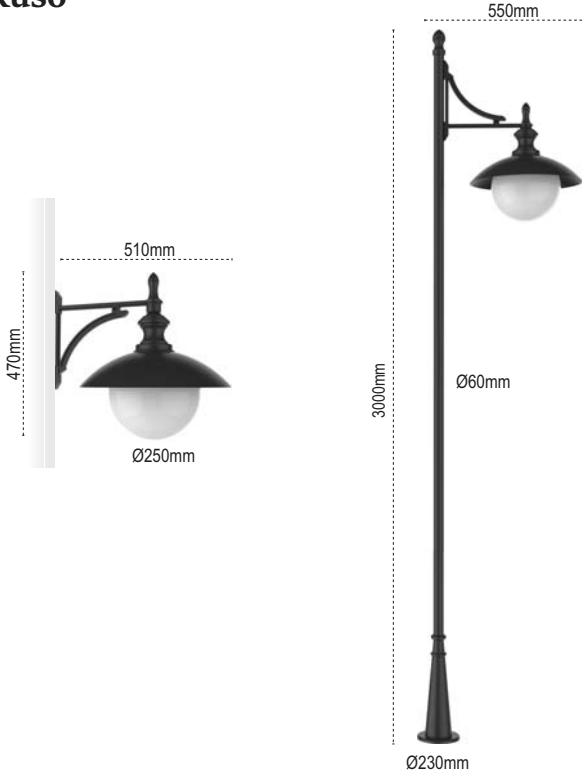

IP 54

Kod No	Özellikler	Koli Adedi	Fiyat
107461	Ruso Tekli Döküm Dipli Direk E27	1	213,00 \$
107463	Ruso İkili Döküm Dipli Direk E27	1	285,00 \$
107393	Ruso Duvar Aplik E27	1	71,00 \$

Arta

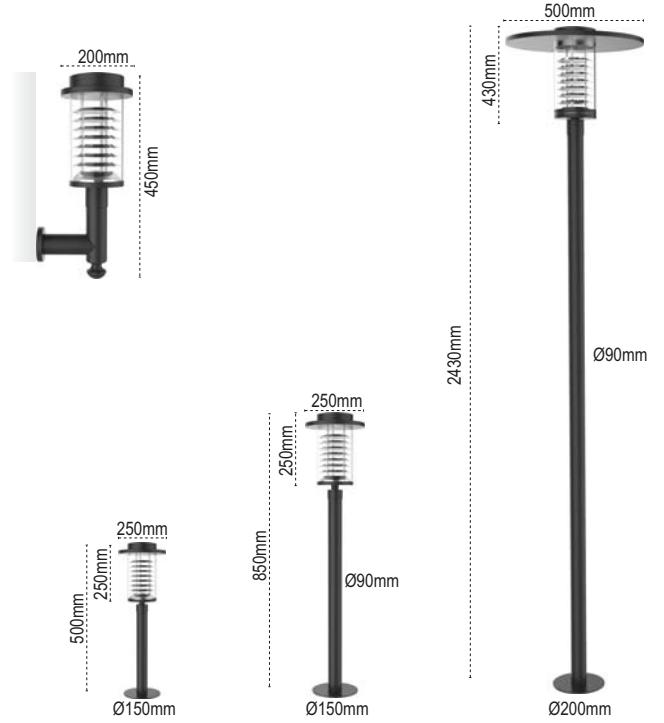

IP 54

Kod No	Özellikler	Koli Adedi	Fiyat
107591	Arta Boru Direk Arm. E27	1	217,00 \$
107565	Arta Boru Çimen Arm. E27	1	124,00 \$
107447	Arta Boru Set Üstü E27	1	124,00 \$
107410	Arta Aplik E27	1	124,00 \$

Milas

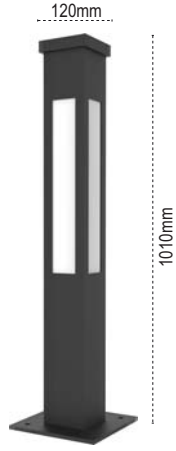

IP 54

Kod No	Özellikler	Koli Adedi	Fiyat
107580	Milas Çimen Armatürü E27	1	129,00 \$
107586	Milas LED Çimen Armatürü 20W	1	202,00 \$

Milet - Arta



5615 4721

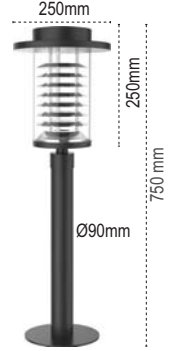

5718 1430

IP 54

Kod No	Özellikler	Koli Adedi	Fiyat
105765	Milet LEDli Çimen Armatürü	1	236,00 \$
107565	Arta Boru Çimen Armatürü E27	1	124,00 \$

Briled

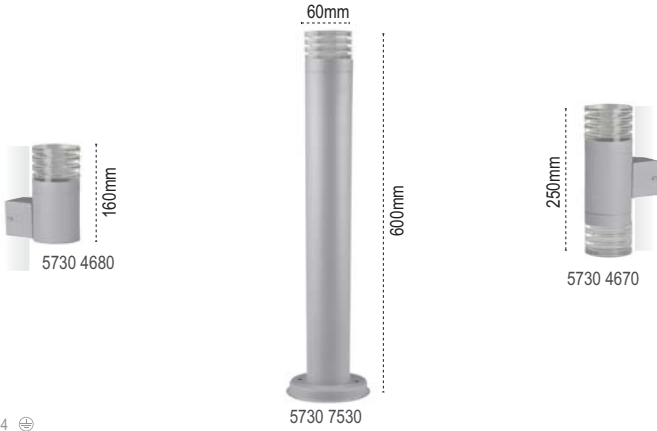

5730 7530

IP 54

Kod No	Özellikler	Koli Adedi	Fiyat
204524	5W Aplik 4000K	6	21,00 \$
203812	5W Çimen Armatürü 4000K	6	39,00 \$
204523	2x5W Aplik 4000K	6	26,00 \$

Noa - Fia



5718 1580

IP 54

Kod No	Özellikler	Koli Adedi	Fiyat
107578	Noa Çimen Armatürü E27	1	84,50 \$
107557	Fia Çimen Armatürü E27	1	124,00 \$



5718 1250

Pedesa - Perge



5718 1330

5718 1720

IP 54

Kod No	Özellikler	Koli Adedi	Fiyat
107564	Pedesa Çimen Armatürü E27	1	67,50 \$
107585	Perge Çimen Armatürü E27	1	67,50 \$

Eva

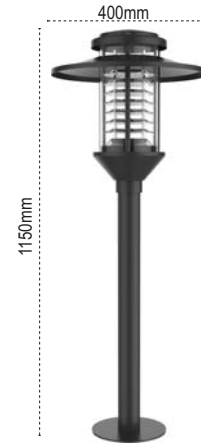

IP 54

Kod No	Özellikler	Koli Adedi	Fiyat
107560	Eva Çimen Armatürü E27	1	124,00 \$

Pelsan Aplik & Set Üstü Armatürler

Cubo

Alüminyum Enjeksiyon

IP 54

Kod No	Özellikler	Koli Adedi	Fiyat
204423	E27	6	71,50 \$

Cono

Alüminyum Enjeksiyon

IP 54

Kod No	Özellikler	Koli Adedi	Fiyat
106049	6W LED 3000K	6	41,50 \$

Verso

Alüminyum Enjeksiyon

IP 54

Kod No	Özellikler	Koli Adedi	Fiyat
204522	E27	8	47,80 \$
204519	6W LED 3000K	12	56,80 \$

Mezzo

Alüminyum Enjeksiyon

IP 54

Kod No	Özellikler	Koli Adedi	Fiyat
204518	6W LED 3000K	6	47,30 \$
204521	9W LED 3000K	10	51,60 \$

Işıl 1

Alüminyum Enjeksiyon

IP 54

Kod No	Özellikler	Koli Adedi	Fiyat
204505	E27	18	30,50 \$

Işıl 2

Alüminyum Enjeksiyon

IP 54

Kod No	Özellikler	Koli Adedi	Fiyat
204506	E27	12	38,00 \$

Dora LED

Alüminyum Enjeksiyon

IP 54

Kod No	Özellikler	Koli Adedi	Fiyat
204529	3W 4000K	24	39,00 \$

Briled 1

Alüminyum Enjeksiyon

IP 54

Kod No	Özellikler	Koli Adedi	Fiyat
204524	2x5W Aplik 4000K	6	21,00 \$

Briled 2

Alüminyum Enjeksiyon

IP 54

Kod No	Özellikler	Koli Adedi	Fiyat
204523	5W Aplik 4000K	6	26,00 \$

Escaled / Escaled S Duvar Gömme Armatürü

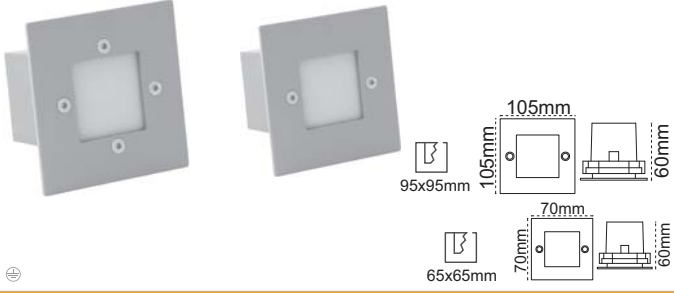

IP 54

Kod No	Özellikler	Koli Adedi	Fiyat
204445	9 LED'li 4000K	50	9,50 \$
204446	12 LED'li 4000K	50	12,60 \$

Dialed / Pialed Duvar Gömme Armatürü

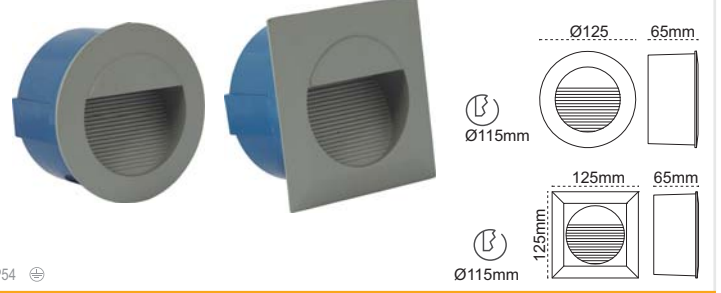

IP54

Kod No	Özellikler	Koli Adedi	Fiyat
204442	14 LED'li 4000K	24	15,80 \$
204441	14 LED'li 4000K	24	15,80 \$

Leraled S Duvar Gömme Armatürü

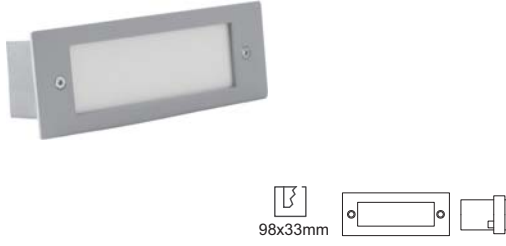

IP64

Kod No	Özellikler	Koli Adedi	Fiyat
204443	14 LED'li 4000K	40	9,50 \$

İndiled Duvar Gömme Armatürü



IP44

Kod No	Özellikler	Koli Adedi	Fiyat
204447	12 LED'li 4000K	20	12,70 \$

Erbaled Bahçe Spotu

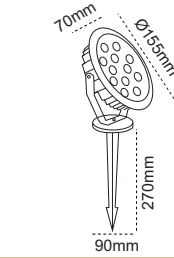

- 6500K
- 4500K
- Amber
- Yeşil

IP65

Kod No	Özellikler	Koli Adedi	Fiyat
108005	20W 6500K	10	78,00 \$
204261	Saplama Aparatı 21cm	1	7,00 \$

Grassled Çimen Armatürü



IP65

Kod No	Özellikler	Koli Adedi	Fiyat
203813	3W 6500K	20	17,00 \$
203816	3W Yeşil	20	17,00 \$
203814	Saplama Aparatı	1	7,00 \$

LED'li Yer Gömme 20 15 LED'li



IP65

Kod No	Özellikler	Koli Adedi	Fiyat
204283	15W Ø20 4000K	8	115,00 \$

LED'li Yer Gömme 15 9 LED'li

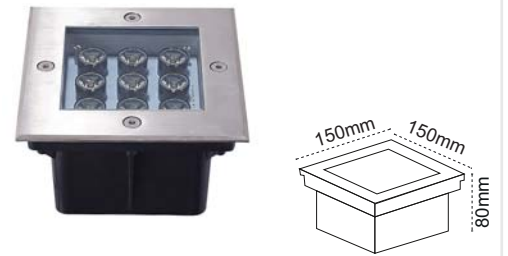

IP65

Kod No	Özellikler	Koli Adedi	Fiyat
204282	9W 15 4000K	12	76,00 \$

2 Kere Kazan

Hem Alırken Hem Kullanırken



● Diğer Lambalara Göre 15 Kat Daha Çevreci

● %90 'a Varan Enerji Tasarrufu

1 LED = 2 Tasarruflu = 4 Halojen = 10 Enkandesen

LED Glop Lambalar



Kod No	Özellikler	Koli Adedi	Fiyat
315105	4,5W 2700K E27 Ø45	100	2,20 \$
315106	4,5W 6400K E27 Ø45	100	2,20 \$
313406	7W 2700K E27 Ø60	100	2,20 \$
313407	7W 6400K E27 Ø60	100	2,30 \$

Kod No	Özellikler	Koli Adedi	Fiyat
313415	9W 6400K E27 Ø60	100	2,45 \$

Dim Edilebilir LED Lamba



Kod No	Özellikler	Koli Adedi	Fiyat
313426	10W 6500K E27	50	8,70 \$

Şarj Edilebilir LED Lamba



Kod No	Özellikler	Koli Adedi	Fiyat
315107	9W 6500K E27	50	9,00 \$

Buji LED Lamba (E14-E27)



Kod No	Özellikler	Koli Adedi	Fiyat
313395	4W 2700K E14	100	2,20 \$
313396	4W 6500K E27	100	2,20 \$

Kapsül Lamba (G4-G9)



Kod No	Özellikler	Koli Adedi	Fiyat
313459	3W Kapsül 3000K G4 12V	100	3,00 \$
313460	3W Kapsül 3000K G9 220V	100	3,00 \$
313461	3W Kapsül 3000K G4 220V	100	3,00 \$



Buji Filament Lamba

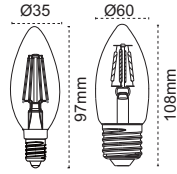

Kod No	Özellikler	Koli Adedi	Fiyat
313437	4W Buji Lamba E27 3000K	100	3,25 \$
313439	4W Buji Lamba E27 6500K	100	3,25 \$
313445	4W Buji Lamba E14 3000K	100	3,25 \$
313446	4W Buji Lamba E14 6500K	100	3,25 \$

Kıvrık Buji Filament Lamba

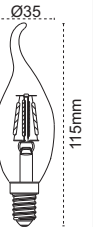

Kod No	Özellikler	Koli Adedi	Fiyat
313436	4W Buji Kıvrık Lamba E14 3000K	100	3,25 \$
313435	4W Buji Kıvrık Lamba E14 6500K	100	3,25 \$

Filament Lamba (Ø60)

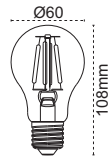

Kod No	Özellikler	Koli Adedi	Fiyat
313438	4W Filament Lamba E27 3000K	100	3,40 \$
313444	4W Filament Lamba E27 6500K	100	3,40 \$

Filament Lamba (Ø95)

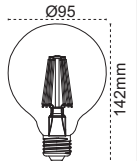

Kod No	Özellikler	Koli Adedi	Fiyat
313441	6W Filament E27 3000K	20	7,50 \$

Filament Lamba (Ø125)

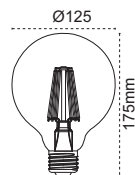

Kod No	Özellikler	Koli Adedi	Fiyat
313442	6W Filament E27 3000K	20	8,55 \$

Filament Lamba (Ø64)

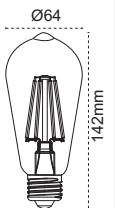

Kod No	Özellikler	Koli Adedi	Fiyat
313440	6W Filament E27 3000K	40	5,45 \$

LED Tüp Lambalar

22w

18w

9w

Değiştirmeden Dönüştürün

LED Tüp Lambalar

Yeni Ürün



	axbxcmm	a	b	c
9W	602x597x29			
18W	1214x1209x30			
22W	1510x1505x30			

Kod No	Özellikler	Koli Adedi	Fiyat
314663	9W 4000K LED Tüp G13	25	5,45 \$
314664	9W 6500K LED Tüp G13	25	5,45 \$
314666	18W 4000K LED Tüp G13	25	6,75 \$
314665	18W 6500K LED Tüp G13	25	6,75 \$

Kod No	Özellikler	Koli Adedi	Fiyat
314671	22W 6500K Pro LED Tüp G13	25	24,90 \$
314669	22W 4000K LED Tüp G13	25	10,30 \$
314668	22W 6500K LED Tüp G13	25	10,30 \$

30-40-50w LED Lamba

Yeni Ürün



Kod No	Özellikler	Koli Adedi	Fiyat
313420	30W 6500K E27	20	15,70 \$

Kod No	Özellikler	Koli Adedi	Fiyat
313421	40W 6500K E27	20	20,20 \$
313422	50W 6500K E27	20	25,80 \$

24w LED Lamba

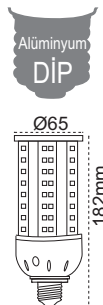

Kod No	Özellikler	Koli Adedi	Fiyat
313418	24W 6500K E27	25	47,00 \$

LED Tube Konverter Kit



Kod No	Özellikler	Koli Adedi	Fiyat
313117	9-18W LED Tüp Konvertör Kit	100	52,60 \$

Sodyum Lambalar



Kod No	Özellikler	Koli Adedi	Fiyat
313504	50 2000K E27	25	7,50 \$
313505	70W 2000K E27	25	7,50 \$
313506	100W 2000K E40	24	8,70 \$
313507	150W 2000K E40	24	9,20 \$

Sodyum Lambalar



Kod No	Özellikler	Koli Adedi	Fiyat
313508	250W 2000K E40	24	11,80 \$
313509	400W 2000K E40	24	13,10 \$
313510	1000W 2000K E40	20	65,50 \$

Metal Lambalar



Kod No	Özellikler	Koli Adedi	Fiyat
313523	150W 5500K E40	24	13,10 \$
313513	250W 5500K E40	24	13,10 \$

Metal Lambalar



Kod No	Özellikler	Koli Adedi	Fiyat
313514	400W 5500K E40	24	13,10 \$
313512	1000W 5500K E40	20	65,50 \$

Metal Lambalar



Kod No	Özellikler	Koli Adedi	Fiyat
313519	70W 5500K G12	100	12,10 \$
313520	150W 5500K G12	100	13,30 \$
313521	70W 3000K G12	100	12,10 \$
313522	150W 3000K G12	100	13,30 \$
313511	70W 5500K Rx7s	100	10,40 \$
313515	150W 5500K Rx7s	100	10,40 \$

Par Lamba



Kod No	Özellikler	Koli Adedi	Fiyat
313408	12X1W PAR38 Lamba 4000K E27	20	10,90 \$
313409	12X1W PAR38 Lamba 6500K E27	20	10,90 \$

Power LED Lamba & COB LED Lamba



Kod No	Özellikler	Koli Adedi	Fiyat
313383	3X1W 6500K GU10	100	3,60 \$
313424	5W COB 3000K GU10	200	4,40 \$
315173	5W COB 6500K GU10	100	4,40 \$

Power LED Lamba



Kod No	Özellikler	Koli Adedi	Fiyat
313384	3X1W 4000K GU10	200	1,70 \$
313388	3X1W 3000K GU5,3	200	1,70 \$
313387	3X1W 6500K GU5,3	200	1,70 \$

Ömrü Boyunca Aynı Işık Çıktısı

- 30.000 saat ömür
- Etkin ısı tekniği sağlayan özel LED kilidi
- 3M Bant
- Her 3 modülde bir kesilebilme
- 12V DC ile çalışır

Sürücü	LED Şerit
2,5 A	max 2,5m
5 A	max 5m
8 A	max 8m
12,5 A	max 12m
17 A	max 15m
30 A	max 30m

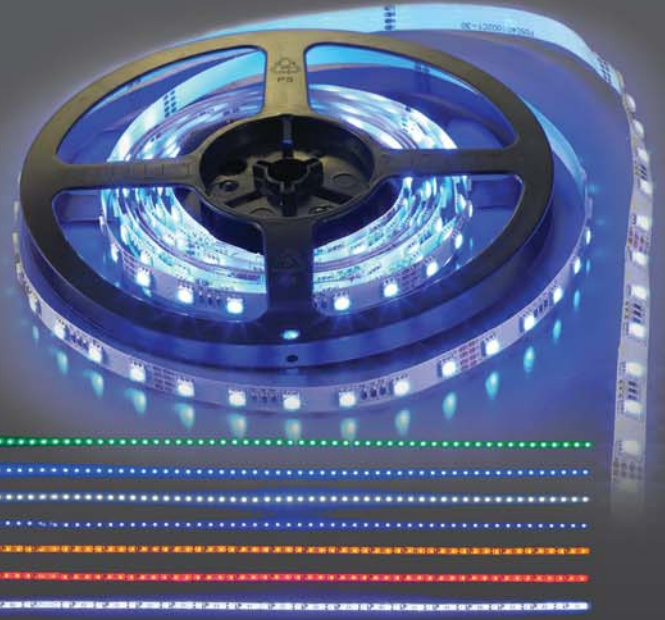

İç Mekan LED Şerit Üç Çip IP20



1,60 \$/m

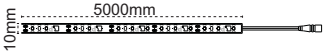

12V DC IP 20

Kod No	Özellikler	Koli Adedi	Fiyat
203687	IP20 SMD LED Beyaz 5 metre	1	8,50 \$
203692	IP20 SMD LED Sarı 5 metre	1	8,50 \$
203689	IP20 SMD LED Kırmızı 5 metre	1	8,50 \$
203693	IP20 SMD LED Yeşil 5 metre	1	8,50 \$
203690	IP20 SMD LED Mavi 5 metre	1	8,50 \$
203688	IP20 SMD LED Ilık Beyaz 5 metre	1	8,50 \$
203691	IP20 SMD LED RGB 5 metre	1	19,70 \$

Dış Mekan LED Şerit Üç Çip IP55



2,14 \$/m



12V DC IP 65

Kod No	Özellikler	Koli Adedi	Fiyat
203694	IP55 SMD LED Beyaz 5 metre	1	11,50 \$
203699	IP55 SMD LED Sarı 5 metre	1	11,50 \$
203696	IP55 SMD LED Kırmızı 5 metre	1	11,50 \$
203700	IP55 SMD LED Yeşil 5 metre	1	11,50 \$
203697	IP55 SMD LED Mavi 5 metre	1	11,50 \$
203695	IP55 SMD LED Ilık Beyaz 5 metre	1	11,50 \$
203698	IP55 SMD LED RGB 5 metre	1	22,50 \$

12V IP20 Sabit Gerilim Sürücüler

ultra slim



313238



313240



313242



313244



313246



313248



IP 20

Kod No	Özellikler	Koli Adedi	Fiyat
313238	36W 12V 3A	100	5,75 \$
313240	60W 12V 5A	120	8,25 \$
313242	100W 12V 8,5A	80	11,10 \$
313244	150W 12V 12,5A	60	13,90 \$

Kod No	Özellikler	Koli Adedi	Fiyat
313246	200W 12V 16,5A	36	17,10 \$
313252	250W 12V 121A	36	20,40 \$
313248	300W 12V 30A	36	21,25 \$

12V IP67 Sabit Gerilim Sürücüler

IP 67



313249



313250

Kod No	Özellikler	Koli Adedi	Fiyat
313249	12V 5A	70	18,85 \$
313250	12V 8,5A	72	33,95 \$

24V LED Şerit ve Sürücüsü IP20 Üç Çip



IP 20

Kod No	Özellikler	Koli Adedi	Fiyat
204801	20W SMD LED Beyaz	1	15,70 \$
314833	60W 24V 2,5A	120	11,40 \$
314834	120W 24V 5A	80	26,50 \$
314835	200W 24V 7,25A	36	27,40 \$
314836	360W 24V 15A	36	28,40 \$

Neon LED

**Ultra Esnek!**

Pelsan Neon LED özel silikonu ve flexible PCB'si sayesinde **ultra esnekliğe** sahiptir.

**Ultra Parlak!**

Özel silikon yapısı ışığın homojenize olmasını sağlarken **ultra parlaklık sunar.**

**Toz ve Su Almaz!**

IP65 koruma sınıfı ile dış mekanda kullanılır.

**Kullanım Kolaylığı!**

Metrede bir kesilebilir.
Esner, her şekil kolayca verilebilir.
220-240V AC ile çalışır. Kullanımı kolaydır.
50 metreye kadar kesintisiz kullanılır.

Ekstra Esnek! Ekstra Parlak!



Neon LED



Aparatlar fiyata dahildir.

- Fişli kablo
- Birleştirme aparatı
- Sonlandırma aparatı

Yeni Ürün



IP 65

Kod No	Özellikler		Koli Adedi	Fiyat
203722	Neon LED Sarı	50m	1	314,00 \$
203719	Neon LED Kırmızı	50m	1	314,00 \$
203720	Neon LED Mavi	50m	1	314,00 \$
203723	Neon LED Yeşil	50m	1	314,00 \$
203717	Neon LED Beyaz	50m	1	314,00 \$
203718	Neon LED Ilık Beyaz	50m	1	314,00 \$
203721	Neon LED RGB	50m	1	535,00 \$
203726	Neon LED Bağlantı Aparatı (Fişli Kablolü)		1	7,60 \$
203727	Neon LED RGB Bağlantı Aparatı (RGB Fişli Kablo)		1	8,60 \$
203725	Neon LED Alüminyum Montaj Aparatı (5 cm)	10'lu	1	7,00 \$
203724	Neon LED Birleştirme Aparatı	10'lu	1	11,00 \$
203728	Neon LED Sonlandırma Aparatı	10'lu	1	4,00 \$

3'lü Zincir Modül

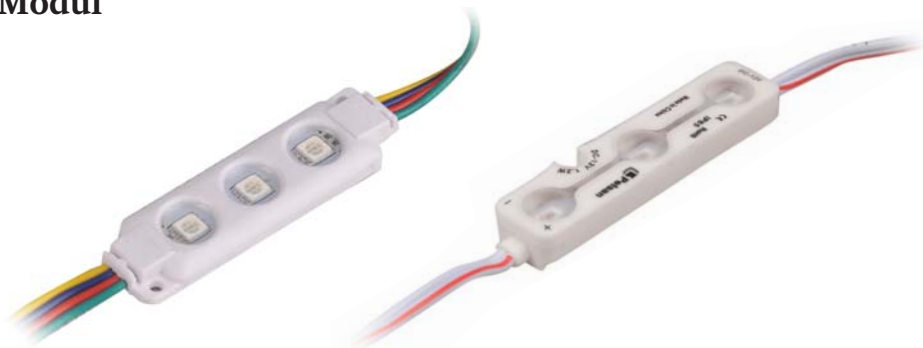

Yeni Ürün

- 3M bant ile kolay montaj
- 6 farklı renk seçeneği
- 12V DC ile çalışma
- IP65 koruma sınıfı

IP 65

Kod No	Özellikler		Koli Adedi	Fiyat
203730	1,2W 12V Beyaz	100'lü	2000	71,25 \$
203731	1,2W 12V Ilık Beyaz	100'lü	2000	71,25 \$
203733	1,2W 12V Kırmızı	100'lü	2000	79,25 \$
203734	1,2W 12V Sarı	100'lü	2000	79,25 \$
203732	1,2W 12V Amber	100'lü	2000	79,25 \$
203729	0,72W 12V RGB	100'lü	2000	105,50 \$

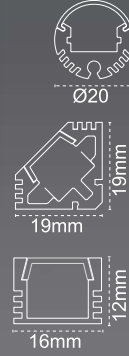

Her Mekana Özel Çözüm!

- Sıva altı, sıva üstü ve köşe seçeneği
- IP67 dış mekan, IP20 iç mekan uygulaması
- 30 / 50 / 100 / 200 cm boy opsiyonu
- 2700 / 3000 / 4000 / 6500K Kırmızı / Yeşil / Mavi / Amber
- 60 / 120 adet LED opsiyonu

İç Mekan LED Bar IP20



IP 20

Kod No	Özellikler	Koli Adedi	Fiyat
107150	LED Bar S.Ü. 19W 60 LED/m 100 cm	1	27,30 \$
107229	LED Bar Köşe 19W 60 LED/m 100 cm	1	27,30 \$
107202	LED Bar S.A. 19W 60 LED/m 100 cm	1	27,30 \$
107185	LED Bar S.Ü. 29W 120 LED/m 100 cm	1	33,90 \$
107341	LED Bar Köşe 29W 120 LED/m 100 cm	1	33,90 \$
107220	LED Bar S.A. 29W 120 LED/m 100 cm	1	33,90 \$

Dış Mekan LED Bar IP67



IP 67

Kod No	Özellikler	Koli Adedi	Fiyat
107156	LED Bar S.Ü. 19W 60 LED/m 100 cm	1	35,00 \$
107235	LED Bar Köşe 19W 60 LED/m 100 cm	1	35,00 \$
107208	LED Bar S.A. 19W 60 LED/m 100 cm	1	35,00 \$
107191	LED Bar S.Ü. 29W 120 LED/m 100 cm	1	42,60 \$
107347	LED Bar Köşe 29W 120 LED/m 100 cm	1	42,60 \$
107223	LED Bar S.A. 29W 120 LED/m 100 cm	1	42,60 \$

İç Mekan LED Bar Sürücüleri



IP 20

Kod No	Özellikler	60 LED/m	120 LED/m	Koli Adedi	Fiyat
314833	60W 24V 2,5A	max 3m	max 2m	120	11,40 \$
314834	120W 24V 5A	max 6m	max 4m	80	26,50 \$
314835	200W 24V 8,5A	max 9m	max 6m	36	27,40 \$
314836	360W 24V 15A	max 16m	max 12m	36	28,40 \$

Dış Mekan LED Bar Sürücüleri IP67



IP 67

Kod No	Özellikler	60 LED/m	120 LED/m	Koli Adedi	Fiyat
313257	150W 24V 6A	max 6m	max 4m	1	47,30 \$
313258	200W 24V 8,5A	max 9m	max 6m	1	56,80 \$

Difüzör Çeşitleri

Kod No	Özellikler	Koli Adedi	Fiyat
312556	Buzlu Bombeli (Sıva Üstü LED Bar) 100 cm Difüzör	1	2,50 \$
312553	Şeffaf Bombeli (Sıva Üstü LED Bar) 100 cm Difüzör	1	2,50 \$
312545	Opal Bombeli (Sıva Üstü LED Bar) 100 cm Difüzör	1	2,50 \$
312566	Buzlu Düz (Sıva Altı / Köşe LED Bar) 100 cm Difüzör	1	2,50 \$
312562	Şeffaf Düz (Sıva Altı / Köşe LED Bar) 100 cm Difüzör	1	2,50 \$
312559	Opal Düz (Sıva Altı / Köşe LED Bar) 100 cm Difüzör	1	2,50 \$

Y.B Metal Halide

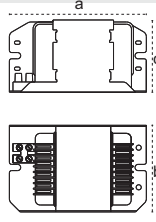

IP 40

Kod No	Özellikler	axbxcmm	Koli Adedi	Fiyat
313048	Metal Halide 35W	155x42x33	24	9,50 \$
313051	Metal Halide 70W	116x64x54	16	10,40 \$
313052	Metal Halide 150W	122x78x66	8	15,40 \$
313053	Metal Halide 250W	135x93x79	4	23,90 \$
313055	Metal Halide 400W	135x93x79	4	26,50 \$
313057	Metal Halide 1000W	197x126x138	2	68,30 \$
313059	Metal Halide 2000W (380V)	225x126x138	1	106,60 \$

Y.B Sodyum Buharlı

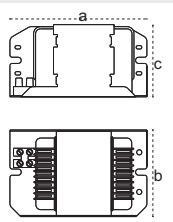

IP 40

Kod No	Özellikler	axbxcmm	Koli Adedi	Fiyat
313037	Sodyum Buharlı 50W	116x64x54	16	9,50 \$
313040	Sodyum Buharlı 70W	116x64x54	16	10,40 \$
313038	Sodyum Buharlı 100W	116x64x54	16	11,10 \$
313041	Sodyum Buharlı 150W	122x78x66	4	15,40 \$
313042	Sodyum Buharlı 250W	135x93x72	4	23,90 \$
313043	Sodyum Buharlı 400W	156x93x69	2	30,90 \$
313047	Sodyum Buharlı 600W	178x126x138	2	53,40 \$
313045	Sodyum Buharlı 1000W	197x126x138	2	68,30 \$

Metal Kitler

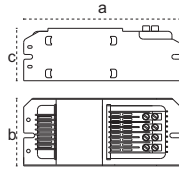

IP 20

Kod No	Özellikler	axbxcmm	Koli Adedi	Fiyat
200078	Metal Kit 35W Balast + ignitör	185x115x88	4	20,20 \$
200069	Metal Kit 70W Balast + ignitör	150x64x54	4	21,40 \$
200070	Metal Kit 150W Balast + ignitör	166x77x65	4	31,10 \$
200074	Metal Kit 250W Balast + ignitör	205x93x79	4	40,00 \$
200076	Metal Kit 400W Balast + ignitör	232x93x79	4	42,60 \$
105227	Olimpiad Kiti 1000W	246x126x138	1	108,00 \$

Sera Kitler

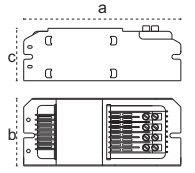

IP 20

Kod No	Özellikler	axbxcmm	Koli Adedi	Fiyat
200066	Sera 400W SB Balast Kiti	232x93x79	4	54,30 \$
200067	Sera 600W SB Balast Kiti	246x126x138	1	93,30 \$

Silver Floresant Balast

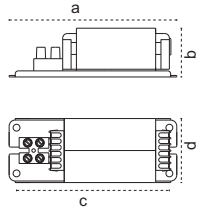

IP 40

Kod No	Özellikler	axbxcxmm	Koli Adedi	Fiyat
312959	15W TLD	100x32,2x87x42	36	3,60 \$
312969	20W TLD	100x32,2x87x42	36	3,60 \$
312975	32W TLD	100x32,2x87x42	36	3,60 \$
312971	36-40W TLD	100x32,2x87x42	36	3,60 \$

Elektronik Balast

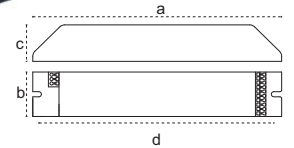

IP 40

Kod No	Özellikler	axbxcxmm	Koli Adedi	Fiyat
313142	1X18W TLD	295x31x29x285	10	13,40 \$
313144	2X18W TLD	295x31x29x285	10	14,60 \$
313143	1X36W TLD	295x31x29x285	10	13,40 \$
313145	2X36W TLD	295x31x29x285	10	14,60 \$
313158	4X14W T5	332x34x32x322	10	17,30 \$

Konvertör Kitler

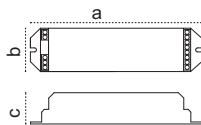

IP 20

Kod No	Özellikler	axbxcmm	Koli Adedi	Fiyat
313089	18-36W Mekanik Balast için 1 Saat	170x43x31	10	43,70 \$
313092	18-36W Mekanik Balast için 3 Saat	170x43x31	10	43,70 \$
313122	18-36W Elektronik Balast için 1 Saat	170x43x31	10	48,50 \$
313123	18-36W Elektronik Balast için 3 Saat	170x43x31	10	48,50 \$

LED Konvertör Kitler



313118



313117

IP 20

Kod No	Özellikler	Koli Adedi	Fiyat
313118	12-110V LED Konvertör Kit	100	29,00 \$
313117	9-18W LED Tube Konvertör Kit	100	52,60 \$

Zaman Ayarlı Ateşleyici

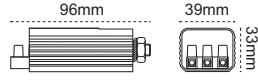

IP 20

Kod No	Özellikler	Koli Adedi	Fiyat
303902	Zaman Ayarlı 50-400W	10	9,40 \$
303880	Ignitör 70-400W	10	6,50 \$

Uzaktan Ateşleyici

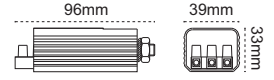

IP 20

Kod No	Özellikler	Koli Adedi	Fiyat
303906	600-1000W (25 m kadar)	10	16,75 \$
303900	Ignitör 600-1000W	10	16,75 \$

Starter

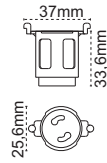

IP 20

Kod No	Özellikler	Koli Adedi	Fiyat
303850	4-65W	25	0,50 \$
303851	Seri 4-22W	25	0,50 \$

Tij Takımı

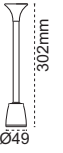

IP 20

Kod No	Özellikler	Koli Adedi	Fiyat
304026	Porselen Tij Takımı E27	50	0,90 \$

Lamba Duyuları

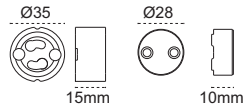

IP 40

Kod No	Özellikler	Koli Adedi	Fiyat
303727	GU10 Porselen Duy	100	0,60 \$
303773	GX5.3 Porselen Duy	100	0,30 \$
303729	G12 Porselen Duy	100	2,10 \$

Porselen Duyular

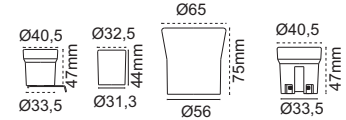

IP 40

Kod No	Özellikler	Koli Adedi	Fiyat
303712	E14 Porselen Duy	480	0,33 \$
303722	E14 Lamalı Porselen Duy	400	0,30 \$
303713	E27 Porselen Duy	400	0,30 \$
303723	E27 Lamalı Porselen Duy	400	0,30 \$
303725	E40 Porselen Duy	100	2,30 \$

IP20 Sabit Akım LED Sürücüler

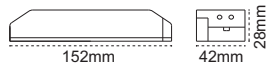

IP 20

Kod No	Özellikler	Koli Adedi	Fiyat
313179	25W 400 mA 25-63 V DC Çıkış Gerilimi	100	21,80 \$
313170	40W 600 mA 33-68 V DC Çıkış Gerilimi	100	29,60 \$

IP20 Sabit Akım LED Sürücüler

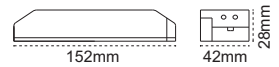

IP 20

Kod No	Özellikler	Koli Adedi	Fiyat
313180	20W 600 mA 16-42 V DC Çıkış Gerilimi	100	22,60 \$
313181	15W 700 mA 11-25 V DC Çıkış Gerilimi	100	13,25 \$

Opak Pano
20x30

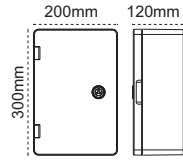

Kod No	Özellikler	Koli Adedi	Fiyat
313323	ABS Taban Saçlı 200X300X120 mm Opak Pano	1	10,50 \$

Opak Pano
25x35

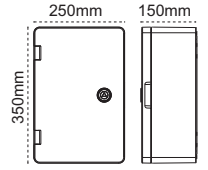

Kod No	Özellikler	Koli Adedi	Fiyat
313324	ABS Taban Saçlı 250X350X150 mm Opak Pano	1	13,60 \$

Opak Pano
30x40

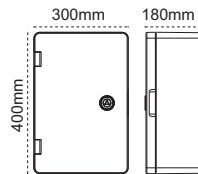

Kod No	Özellikler	Koli Adedi	Fiyat
313325	ABS Taban Saçlı 300X400X180 mm Opak Pano	1	18,00 \$

Opak Pano
40x50

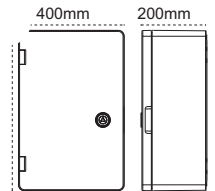

Kod No	Özellikler	Koli Adedi	Fiyat
313326	ABS Taban Saçlı 400X500X210 mm Opak Pano	1	27,60 \$

Keira Antibakteriyel Anahtar ve Priz Serisi



Antibakteriyel K13

Kod No	Cinsi	Koli Ad.	Keira Antibakteriyel Seri
Anahtar Grubu			
5963 1001	Anahtar	120	1,48 \$
5963 1002	Light	120	1,54 \$
5963 1003	Kapı otomatığı	120	1,54 \$
5963 1004	Zil anahtarı	120	1,54 \$
5963 1005	Komitatör	120	1,80 \$
5963 1006	Vavien	120	1,80 \$
5963 1007	Permitatör	120	2,22 \$
5963 1008	Komitatör vavien	120	2,44 \$
5963 1009	Jaluzi anahtarı	120	2,86 \$
5963 1010	Şofben anahtarı	120	4,62 \$
5963 1011	3'lü anahtar	120	3,94 \$
Priz Grubu			
5963 1014	Priz	120	1,48 \$
5963 1015	Topraklı priz	120	1,74 \$
5963 1016	Çocuk korumalı topraklı priz	120	2,38 \$
5963 1017	UPS topraklı priz	120	2,22 \$
5963 1018	UPS çocuk korumalı topraklı priz	120	2,34 \$
5963 1019	Kapaklı topraklı priz	120	2,00 \$
5963 1020	Çocuk korumalı kapaklı topraklı priz	120	2,72 \$
5963 1021	UPS kapaklı topraklı priz	120	3,64 \$
5963 1023	İkili priz	100	1,96 \$
5963 1024	İkili topraklı priz	70	2,12 \$
TV/Radyo Grubu			
5963 1030	TV priz geçişli	120	2,68 \$
5963 1031	TV priz sonlu	120	2,68 \$
5963 1032	TV priz dirençsiz	120	2,68 \$
5963 1033	Uydu prizi F komnektörlü geçişli	120	4,00 \$
5963 1034	Uydu prizi F komnektörlü sonlu	120	4,00 \$
5963 1035	TV - Radyo priz geçişli	120	7,36 \$
5963 1036	TV - Radyo priz sonlu	120	7,36 \$
5963 1037	TV - Sat priz geçişli	120	11,30 \$
5963 1038	TV - Sat priz sonlu	120	11,30 \$

Kod No	Cinsi	Koli Ad.	Keira Antibakteriyel Seri
iletifim Grubu			
5963 1040	Telefon prizi	120	1,48 \$
5963 1041	Numeris telefon prizi (RJ11)	120	1,94 \$
5963 1042	İkili numeris (RJ11)	120	3,02 \$
5963 1043	Data numeris (RJ45CAT5-RJ11)	120	7,52 \$
5963 1044	Data priz (RJ45CAT5)	120	7,36 \$
5963 1045	İkili data priz (RJ45CAT5)	120	12,10 \$
5963 1046	Data jaksız	120	1,80 \$
5963 1047	Data priz (RJ45CAT6)	120	7,36 \$
5963 1048	İkili data priz (RJ45CAT6)	120	12,10 \$
5963 1049	Data - Numeris (RJ45CAT6-RJ11)	120	7,52 \$
5963 1050	Müzik Yayın Prizi	80	14,94 \$
5963 1052	VGA Prizi	80	23,28 \$
5963 1059	Müzik yayın anahtarı	80	10,50 \$
Dimmer Grubu			
5963 1055	Dimmer 600W	80	8,78 \$
5963 1056	Dimmer 1000W	80	9,54 \$
5963 1057	Dimmer vavien 600W	80	17,54 \$
5963 1058	Dimmer RC 300W	80	19,12 \$
Işıklı Anahtar Grubu			
5963 1070	Işıklı anahtar	120	2,16 \$
5963 1071	Işıklı light	120	2,20 \$
5963 1072	Işıklı komitatör	120	2,52 \$
5963 1073	Işıklı vavien	120	2,52 \$
5963 1074	Işıklı etiketli zil	120	2,46 \$
5963 1075	Işıklı dimmer 600W	80	9,18 \$
5963 1076	Işıklı dimmer 1000W	80	9,18 \$
5963 1077	Işıklı dimmer vavien 600W	80	17,94 \$
5963 1078	Işıklı dimmer RC 300W	80	19,48 \$
Çerçeveler			
5963 1081	2'li çerçeve yatay-dikey	200	1,06 \$
5963 1082	3'lü çerçeve yatay-dikey	150	1,34 \$
5963 1083	4'lü çerçeve yatay-dikey	50	1,72 \$
5963 1084	5'li çerçeve yatay-dikey	50	2,12 \$
5963 1085	6'li çerçeve yatay-dikey	50	2,52 \$

Keira Beyaz Anahtar ve Priz Serisi

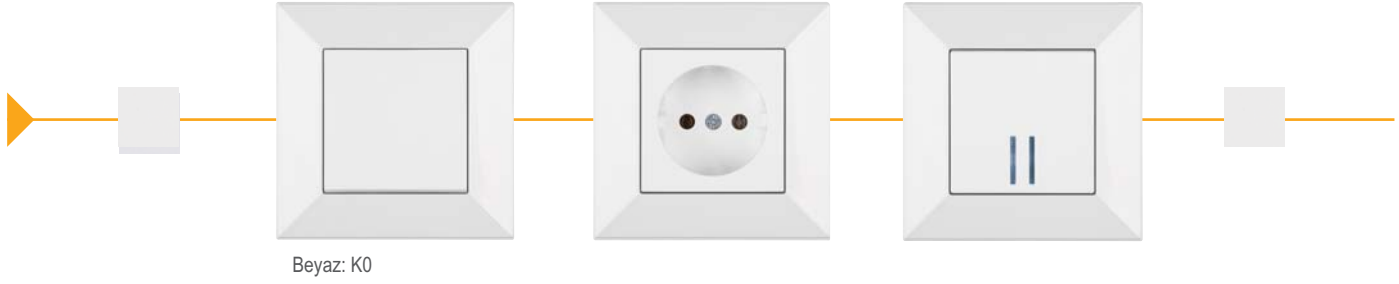

Keira Krem Anahtar ve Priz Serisi

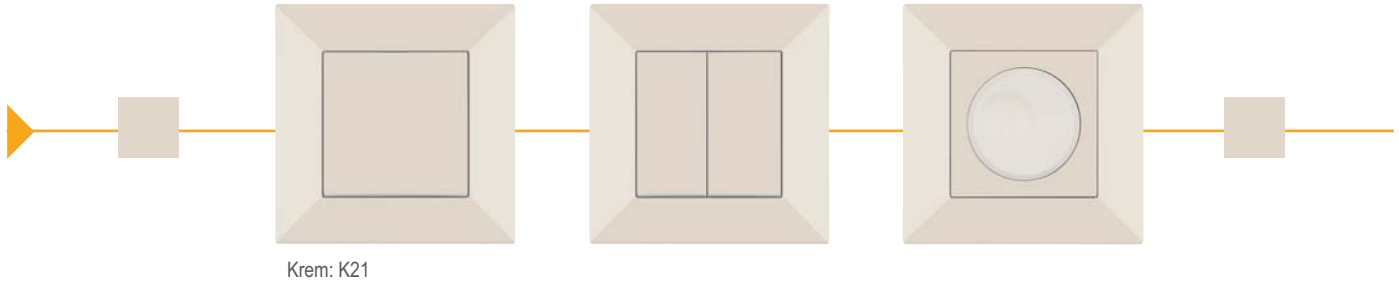

Kod No	Cinsi	Koli Ad.	Keira Beyaz & Krem Seri
Anahtar Grubu			
5963 1001	Anahtar	120	1,38 \$
5963 1002	Light	120	1,46 \$
5963 1003	Kapı otomatığı	120	1,46 \$
5963 1004	Zil anahtarı	120	1,46 \$
5963 1005	Komitatör	120	1,66 \$
5963 1006	Vavien	120	1,66 \$
5963 1007	Permitatör	120	2,16 \$
5963 1008	Komitatör vavien	120	2,34 \$
5963 1009	Jaluzi anahtarı	120	2,76 \$
5963 1010	Şofben anahtarı	120	4,42 \$
5963 1011	3'lü anahtar	120	3,76 \$
Priz Grubu			
5963 1014	Priz	120	1,38 \$
5963 1015	Topraklı priz	120	1,64 \$
5963 1016	Çocuk korumalı topraklı priz	120	2,22 \$
5963 1017	UPS topraklı priz	120	2,16 \$
5963 1018	UPS çocuk korumalı topraklı priz	120	2,22 \$
5963 1019	Kapaklı topraklı priz	120	1,92 \$
5963 1020	Çocuk korumalı kapaklı topraklı priz	120	2,64 \$
5963 1021	UPS kapaklı topraklı priz	120	3,50 \$
5963 1023	İkili priz	100	1,88 \$
5963 1024	İkili topraklı priz	70	2,04 \$
TV/Radyo Grubu			
5963 1030	TV priz geçişli	120	2,58 \$
5963 1031	TV priz sonlu	120	2,58 \$
5963 1032	TV priz dirençsiz	120	2,58 \$
5963 1033	Uydu prizi F konnektörlü geçişli	120	3,90 \$
5963 1034	Uydu prizi F konnektörlü sonlu	120	3,90 \$
5963 1035	TV - Radyo priz geçişli	120	7,04 \$
5963 1036	TV - Radyo priz sonlu	120	7,04 \$
5963 1037	TV - Sat priz geçişli	120	10,92 \$
5963 1038	TV - Sat priz sonlu	120	10,92 \$

Kod No	Cinsi	Koli Ad.	Keira Beyaz & Krem Seri
iletisim Grubu			
5963 1040	Telefon prizi	120	1,38 \$
5963 1041	Numeris telefon prizi (RJ11)	120	1,84 \$
5963 1042	İkili numeris (RJ11)	120	2,92 \$
5963 1043	Data numeris (RJ45CAT5-RJ11)	120	7,34 \$
5963 1044	Data priz (RJ45CAT5)	120	7,04 \$
5963 1045	İkili data priz (RJ45CAT5)	120	11,68 \$
5963 1046	Data jaksız	120	1,66 \$
5963 1047	Data priz (RJ45CAT6)	120	7,04 \$
5963 1048	İkili data priz (RJ45CAT6)	120	11,68 \$
5963 1049	Data - Numeris (RJ45CAT6-RJ11)	120	7,34 \$
5963 1050	Müzik Yayın Prizi	80	14,52 \$
5963 1052	VGA Prizi	80	22,90 \$
5963 1059	Müzik yayın anahtarı	80	10,30 \$
Dimmer Grubu			
5963 1055	Dimmer 600W	80	8,60 \$
5963 1056	Dimmer 1000W	80	9,34 \$
5963 1057	Dimmer vavien 600W	80	17,16 \$
5963 1058	Dimmer RC 300W	80	18,70 \$
Işıklı Anahtar Grubu			
5963 1070	Işıklı anahtar	120	2,04 \$
5963 1071	Işıklı light	120	2,12 \$
5963 1072	Işıklı komitatör	120	2,44 \$
5963 1073	Işıklı vavien	120	2,44 \$
5963 1074	Işıklı etiketli zil	120	2,38 \$
5963 1075	Işıklı dimmer 600W	80	8,98 \$
5963 1076	Işıklı dimmer 1000W	80	9,76 \$
5963 1077	Işıklı dimmer vavien 600W	80	17,54 \$
5963 1078	Işıklı dimmer RC 300W	80	19,12 \$
Çerçeveler			
5963 1081	2'li çerçeve yatay-dikey	200	0,96 \$
5963 1082	3'lü çerçeve yatay-dikey	150	1,22 \$
5963 1083	4'lü çerçeve yatay-dikey	50	1,62 \$
5963 1084	5'li çerçeve yatay-dikey	50	2,00 \$
5963 1085	6'lı çerçeve yatay-dikey	50	2,40 \$

Konfigürasyon: Beyaz: K0
Krem: K21



Keira Füme Anahtar ve Priz Serisi



Füme: K25

Keira Saten Anahtar ve Priz Serisi

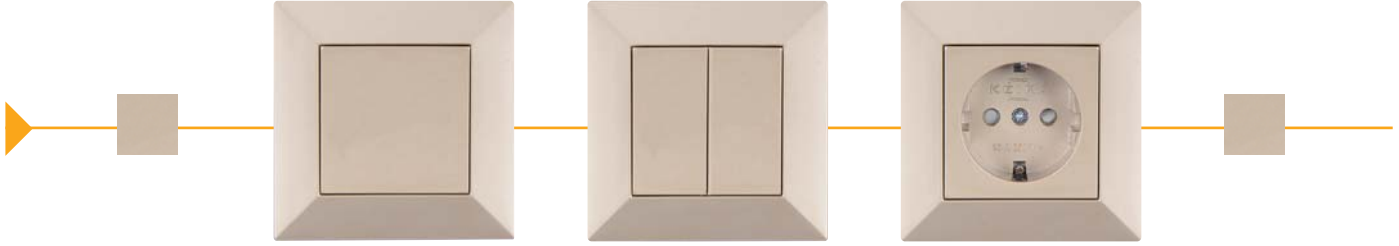

Saten: K24

Kod No	Cinsi	Koli Ad.	Keira Metalik Seri
Anahtar Grubu			
5963 1001	Anahtar	120	2,46 \$
5963 1002	Light	120	2,56 \$
5963 1003	Kapı otomatiği	120	2,56 \$
5963 1004	Zil anahtarı	120	2,56 \$
5963 1005	Komitatör	120	2,78 \$
5963 1006	Vavien	120	2,78 \$
5963 1007	Permitatör	120	3,30 \$
5963 1008	Komitatör vavien	120	3,48 \$
5963 1009	Jaluzi anahtarı	120	3,88 \$
5963 1010	Şofben anahtarı	120	5,80 \$
5963 1011	3'lü anahtar	120	5,08 \$
Priz Grubu			
5963 1014	Priz	120	2,46 \$
5963 1015	Topraklı priz	120	2,76 \$
5963 1016	Çocuk korumalı topraklı priz	120	3,38 \$
5963 1017	UPS topraklı priz	120	3,30 \$
5963 1018	UPS çocuk korumalı topraklı priz	120	3,34 \$
5963 1019	Kapaklı topraklı priz	120	3,04 \$
5963 1020	Çocuk korumalı kapaklı topraklı priz	120	3,78 \$
5963 1021	UPS kapaklı topraklı priz	120	4,68 \$
5963 1023	İkili priz	100	3,00 \$
5963 1024	İkili topraklı priz	70	3,14 \$
TV/Radyo Grubu			
5963 1030	TV priz geçişli	120	3,72 \$
5963 1031	TV priz sonlu	120	3,72 \$
5963 1032	TV priz dirençsiz	120	3,72 \$
5963 1033	Uydu prizi F konnektörlü geçişli	120	5,08 \$
5963 1034	Uydu prizi F konnektörlü sonlu	120	5,08 \$
5963 1035	TV - Radyo priz geçişli	120	8,32 \$
5963 1036	TV - Radyo priz sonlu	120	8,32 \$
5963 1037	TV - Sat priz geçişli	120	12,36 \$
5963 1038	TV - Sat priz sonlu	120	12,36 \$

Kod No	Cinsi	Koli Ad.	Keira Metalik Seri
İletişim Grubu			
5963 1040	Telefon prizi	120	2,46 \$
5963 1041	Numeris telefon prizi (RJ11)	120	2,96 \$
5963 1042	İkili numeris (RJ11)	120	4,06 \$
5963 1043	Data numeris (RJ45CAT5-RJ11)	120	8,64 \$
5963 1044	Data priz (RJ45CAT5)	120	8,32 \$
5963 1045	İkili data priz (RJ45CAT5)	120	13,16 \$
5963 1046	Data jaksız	120	2,78 \$
5963 1047	Data priz (RJ45CAT6)	120	8,32 \$
5963 1048	İkili data priz (RJ45CAT6)	120	13,16 \$
5963 1049	Data - Numeris (RJ45CAT6-RJ11)	120	8,64 \$
5963 1050	Müzik Yayın Prizi	80	16,24 \$
5963 1052	VGA Prizi	80	25,16 \$
5963 1059	Müzik yayın anahtarı	80	11,68 \$
Dimmer Grubu			
5963 1055	Dimmer 600W	80	10,18 \$
5963 1056	Dimmer 1000W	80	9,60 \$
5963 1057	Dimmer vavien 600W	80	18,80 \$
5963 1058	Dimmer RC 300W	80	20,44 \$
İşıkli Anahtar Grubu			
5963 1070	İşıkli anahtar	120	3,20 \$
5963 1071	İşıkli light	120	3,26 \$
5963 1072	İşıkli komitatör	120	3,58 \$
5963 1073	İşıkli vavien	120	3,58 \$
5963 1074	İşıkli etiketli zil	120	3,48 \$
5963 1075	İşıkli dimmer 600W	80	10,30 \$
5963 1076	İşıkli dimmer 1000W	80	11,14 \$
5963 1077	İşıkli dimmer vavien 600W	80	17,60 \$
5963 1078	İşıkli dimmer RC 300W	80	20,84 \$
Çerçeveler			
5963 1081	2'li çerçeve yatay-dikey	200	2,04 \$
5963 1082	3'lü çerçeve yatay-dikey	150	2,30 \$
5963 1083	4'lü çerçeve yatay-dikey	50	2,72 \$
5963 1084	5'li çerçeve yatay-dikey	50	3,12 \$
5963 1085	6'lı çerçeve yatay-dikey	50	3,56 \$

Keira Kiraz Anahtar ve Priz Serisi

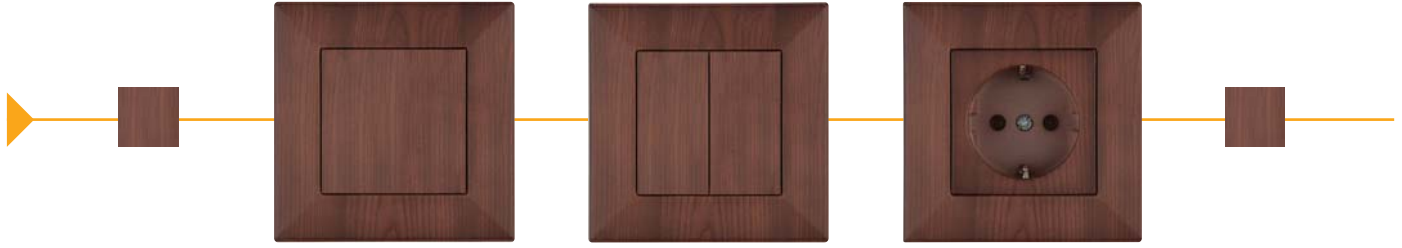

Kiraz: K23

Keira Meşe Anahtar ve Priz Serisi

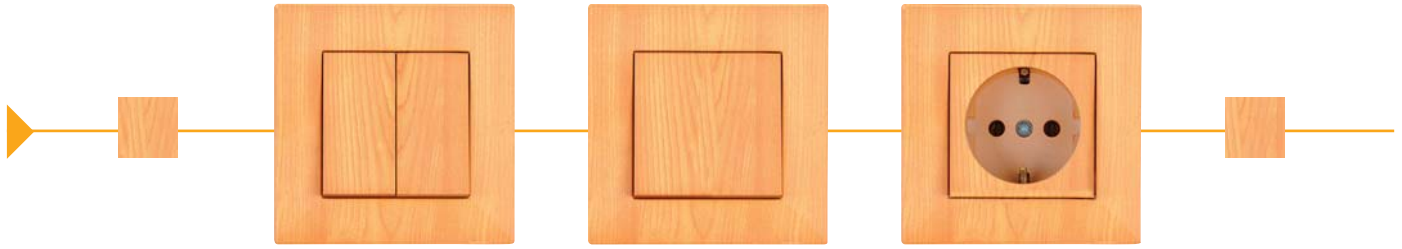

Meşe: K22

Kod No	Cinsi	Koli Ad.	Keira Ahşap Seri
Anahtar Grubu			
5963 1001	Anahtar	120	2,58 \$
5963 1002	Light	120	3,46 \$
5963 1003	Kapı otomatiği	120	3,46 \$
5963 1004	Zil anahtarı	120	3,46 \$
5963 1005	Komitatör	120	3,78 \$
5963 1006	Vavien	120	3,78 \$
5963 1007	Permitatör	120	3,34 \$
5963 1008	Komitatör vavien	120	3,58 \$
5963 1009	Jaluzi anahtarı	120	3,94 \$
5963 1010	Şofben anahtarı	120	5,84 \$
5963 1011	3'lü anahtar	120	5,14 \$
Priz Grubu			
5963 1014	Priz	120	2,58 \$
5963 1015	Topraklı priz	120	2,88 \$
5963 1016	Çocuk korumalı topraklı priz	120	3,46 \$
5963 1017	UPS topraklı priz	120	3,34 \$
5963 1018	UPS çocuk korumalı topraklı priz	120	3,44 \$
5963 1019	Kapaklı topraklı priz	120	3,12 \$
5963 1020	Çocuk korumalı kapaklı topraklı priz	120	3,84 \$
5963 1021	UPS kapaklı topraklı priz	120	4,70 \$
5963 1023	İkili priz	100	3,10 \$
5963 1024	İkili topraklı priz	70	3,22 \$
TV/Radyo Grubu			
5963 1030	TV priz geçişli	120	3,78 \$
5963 1031	TV priz sonlu	120	3,78 \$
5963 1032	TV priz dirençsiz	120	3,78 \$
5963 1033	Uydu prizi F komnektörlü geçişli	120	5,14 \$
5963 1034	Uydu prizi F komnektörlü sonlu	120	5,14 \$
5963 1035	TV - Radyo priz geçişli	120	11,78 \$
5963 1036	TV - Radyo priz sonlu	120	11,78 \$
5963 1037	TV - Sat priz geçişli	120	12,14 \$
5963 1038	TV - Sat priz sonlu	120	12,14 \$

Kod No	Cinsi	Koli Ad.	Keira Ahşap Seri
iletişim Grubu			
5963 1040	Telefon prizi	120	2,58 \$
5963 1041	Numeris telefon prizi (RJ11)	120	3,02 \$
5963 1042	İkili numeris (RJ11)	120	4,14 \$
5963 1043	Data numeris (RJ45CAT5-RJ11)	120	8,52 \$
5963 1044	Data priz (RJ45CAT5)	120	11,78 \$
5963 1045	İkili data priz (RJ45CAT5)	120	12,90 \$
5963 1046	Data jaksız	120	2,90 \$
5963 1047	Data priz (RJ45CAT6)	120	11,78 \$
5963 1048	İkili data priz (RJ45CAT6)	120	12,90 \$
5963 1049	Data - Numeris (RJ45CAT6-RJ11)	120	8,52 \$
5963 1050	Müzik Yayın Prizi	80	15,90 \$
5963 1052	VGA Prizi	80	24,08 \$
5963 1059	Müzik yayın anahtarı	80	11,50 \$
Dimmer Grubu			
5963 1055	Dimmer 600W	80	9,78 \$
5963 1056	Dimmer 1000W	80	10,58 \$
5963 1057	Dimmer vavien 600W	80	18,34 \$
5963 1058	Dimmer RC 300W	80	19,92 \$
İşıkli Anahtar Grubu			
5963 1070	İşıkli anahtar	120	3,24 \$
5963 1071	İşıkli light	120	3,34 \$
5963 1072	İşıkli komitatör	120	3,64 \$
5963 1073	İşıkli vavien	120	3,64 \$
5963 1074	İşıkli etiketli zil	120	3,58 \$
5963 1075	İşıkli dimmer 600W	80	10,18 \$
5963 1076	İşıkli dimmer 1000W	80	10,94 \$
5963 1077	İşıkli dimmer vavien 600W	80	17,18 \$
5963 1078	İşıkli dimmer RC 300W	80	20,30 \$
Çerçeveler			
5963 1081	2'li çerçeve yatay-dikey	200	2,16 \$
5963 1082	3'lü çerçeve yatay-dikey	150	2,40 \$
5963 1083	4'lü çerçeve yatay-dikey	50	2,84 \$
5963 1084	5'li çerçeve yatay-dikey	50	3,22 \$
5963 1085	6'li çerçeve yatay-dikey	50	3,60 \$

Konfigürasyon: Kiraz: K23
Meşe: K22



Keira Cam-Corian



Keira Mermer Anahtar ve Priz Serisi



Kod No	Cinsi	Koli Ad.	Keira Cam ve Mermer Serisi
Anahtar Grubu			
5963 1001	Anahtar	120	9,98 \$
5963 1002	Light	120	10,06 \$
5963 1003	Kapı otomatığı	120	10,06 \$
5963 1004	Zil anahtarı	120	10,06 \$
5963 1005	Komitatör	120	10,30 \$
5963 1006	Vavien	120	10,30 \$
5963 1007	Permitatör	120	10,86 \$
5963 1008	Komitatör vavien	120	11,08 \$
5963 1009	Jaluzi anahtarı	120	11,54 \$
5963 1010	Şofben anahtarı	120	11,54 \$
Priz Grubu			
5963 1014	Priz	120	9,98 \$
5963 1015	Topraklı priz	120	10,28 \$
5963 1016	Çocuk korumalı topraklı priz	120	11,02 \$
5963 1017	UPS topraklı priz	120	10,86 \$
5963 1018	UPS çocuk korumalı topraklı priz	120	10,94 \$
5963 1019	Kapaklı topraklı priz	120	10,58 \$
5963 1020	Çocuk korumalı kapaklı topraklı priz	120	11,42 \$
5963 1021	UPS kapaklı topraklı priz	120	12,46 \$
TV/Radyo Grubu			
5963 1030	TV priz geçişli	120	11,38 \$
5963 1031	TV priz sonlu	120	11,38 \$
5963 1032	TV priz dirençsiz	120	11,38 \$
5963 1033	Uydu prizi F komnektörlü geçişli	120	12,92 \$
5963 1034	Uydu prizi F komnektörlü sonlu	120	12,92 \$
5963 1035	TV - Radyo priz geçişli	120	16,50 \$
5963 1036	TV - Radyo priz sonlu	120	16,50 \$
5963 1037	TV - Sat priz geçişli	120	21,06 \$
5963 1038	TV - Sat priz sonlu	120	21,06 \$

Kod No	Cinsi	Koli Ad.	Keira Cam ve Mermer Serisi
iletifim Grubu			
5963 1040	Telefon prizi	120	9,98 \$
5963 1041	Numeris telefon prizi (RJ11)	120	10,48 \$
5963 1042	İkili numeris (RJ11)	120	11,78 \$
5963 1043	Data numeris (RJ45CAT5-RJ11)	120	16,92 \$
5963 1044	Data priz (RJ45CAT5)	120	16,50 \$
5963 1045	İkili data priz (RJ45CAT5)	120	21,98 \$
5963 1046	Data jaksız	120	10,30 \$
5963 1047	Data priz (RJ45CAT6)	120	16,50 \$
5963 1048	İkili data priz (RJ45CAT6)	120	21,98 \$
5963 1049	Data - Numeris (RJ45CAT6-RJ11)	120	16,92 \$
5963 1050	Müzik Yayın Prizi	80	22,90 \$
5963 1052	VGA Prizi	80	26,72 \$
5963 1059	Müzik yayın anahtarı	80	20,32 \$
Dimmer Grubu			
5963 1055	Dimmer 600W	80	18,34 \$
5963 1056	Dimmer 1000W	80	19,26 \$
5963 1057	Dimmer vavien 600W	80	28,32 \$
5963 1058	Dimmer RC 300W	80	30,16 \$
Işıklı Anahtar Grubu			
5963 1070	Işıklı anahtar	120	10,74 \$
5963 1071	Işıklı light	120	10,84 \$
5963 1072	Işıklı komitatör	120	11,20 \$
5963 1073	Işıklı vavien	120	11,20 \$
5963 1074	Işıklı etiketli zil	120	11,10 \$
5963 1075	Işıklı dimmer 600W	80	18,80 \$
5963 1076	Işıklı dimmer 1000W	80	19,70 \$
5963 1077	Işıklı dimmer vavien 600W	80	28,78 \$
5963 1078	Işıklı dimmer RC 300W	80	30,56 \$
Çerçeveler			
5963 1081	2'li çerçeve yatay-dikey	200	10,46 \$
5963 1082	3'lü çerçeve yatay-dikey	150	11,34 \$

Onyx Beyaz Anahtar ve Priz Serisi



Beyaz: K0

Onyx Krem Anahtar ve Priz Serisi



Krem: K21

Kod No	Cinsi	Koli Ad.	Beyaz ve Krem Serisi
Anahtar Grubu			
5963 3001	Anahtar	120	1,38 \$
5963 3002	Light	120	1,46 \$
5963 3003	Kapı otomatığı	120	1,46 \$
5963 3004	Zil anahtarı	120	1,46 \$
5963 3005	Komitatör	120	1,66 \$
5963 3006	Vavien	120	1,66 \$
5963 3007	Permitatör	120	2,16 \$
5963 3008	Komitatör vavien	120	2,34 \$
5963 3009	Jaluzi anahtarı	120	2,76 \$
5963 3010	Şofben anahtarı	120	4,42 \$
5963 3011	3'lü anahtar	120	3,76 \$
Priz Grubu			
5963 3014	Priz	120	1,38 \$
5963 3015	Topraklı priz	120	1,64 \$
5963 3016	Çocuk korumalı topraklı priz	120	2,22 \$
5963 3017	UPS topraklı priz	120	2,16 \$
5963 3018	UPS çocuk korumalı topraklı priz	120	2,22 \$
5963 3019	Kapaklı topraklı priz	120	1,92 \$
5963 3020	Çocuk korumalı kapaklı topraklı priz	120	2,64 \$
5963 3021	UPS kapaklı topraklı priz	120	3,50 \$
5963 3023	İkili priz	100	1,88 \$
5963 3024	İkili topraklı priz	70	2,04 \$
TV/Radyo Grubu			
5963 3030	TV priz geçişi	120	2,58 \$
5963 3031	TV priz sonlu	120	2,58 \$
5963 3032	TV priz dirençsiz	120	2,58 \$
5963 3033	Uydu prizi F konnektörlü geçişi	120	3,90 \$
5963 3034	Uydu prizi F konnektörlü sonlu	120	3,90 \$
5963 3035	TV - Radyo priz geçişi	120	7,04 \$
5963 3036	TV - Radyo priz sonlu	120	7,04 \$
5963 3037	TV - Sat priz geçişi	120	10,92 \$
5963 3038	TV - Sat priz sonlu	120	10,92 \$

Kod No	Cinsi	Koli Ad.	Beyaz ve Krem Serisi
İletişim Grubu			
5963 3040	Telefon prizi	120	1,38 \$
5963 3041	Numeris telefon prizi (RJ11)	120	1,84 \$
5963 3042	İkili numeris (RJ11)	120	2,92 \$
5963 3043	Data numeris (RJ45CAT5-RJ11)	120	7,34 \$
5963 3044	Data priz (RJ45CAT5)	120	7,04 \$
5963 3045	İkili data priz (RJ45CAT5)	120	11,68 \$
5963 3046	Data jaksız	120	1,66 \$
5963 3047	Data priz (RJ45CAT6)	120	7,04 \$
5963 3048	İkili data priz (RJ45CAT6)	120	11,68 \$
5963 3049	Data - Numeris (RJ45CAT6-RJ11)	120	7,34 \$
5963 3050	Müzik Yayın Prizi	80	14,52 \$
5963 3052	VGA Prizi	80	22,90 \$
5963 3059	Müzik yayın anahtarı	80	10,30 \$
Dimmer Grubu			
5963 3055	Dimmer 600W	80	8,60 \$
5963 3056	Dimmer 1000W	80	9,34 \$
5963 3057	Dimmer vavien 600W	80	17,16 \$
5963 3058	Dimmer RC 300W	80	18,70 \$
İşıkli Anahtar Grubu			
5963 3070	İşıkli anahtar	120	2,04 \$
5963 3071	İşıkli light	120	2,12 \$
5963 3072	İşıkli komitatör	120	2,44 \$
5963 3073	İşıkli vavien	120	2,44 \$
5963 3074	İşıkli etiketli zil	120	2,38 \$
5963 3075	İşıkli dimmer 600W	80	8,98 \$
5963 3076	İşıkli dimmer 1000W	80	9,76 \$
5963 3077	İşıkli dimmer vavien 600W	80	17,54 \$
5963 3078	İşıkli dimmer RC 300W	80	19,12 \$
Çerçeveler			
5963 3081	2'li çerçeve yatay-dikey	200	0,96 \$
5963 3082	3'lü çerçeve yatay-dikey	150	1,22 \$
5963 3083	4'lü çerçeve yatay-dikey	50	1,62 \$
5963 3084	5'li çerçeve yatay-dikey	50	2,00 \$
5963 3085	6'lı çerçeve yatay-dikey		2,40 \$

Konfigürasyon: Beyaz: K0
Krem: K21



Onyx Füme Anahtar ve Priz Serisi



Füme: K25

Onyx Saten Anahtar ve Priz Serisi



Saten: K24

Kod No	Cinsi	Koli Ad.	Onyx Metalik Seri
Anahtar Grubu			
5963 3001	Anahtar	120	2,46 \$
5963 3002	Light	120	2,56 \$
5963 3003	Kapı otomatiği	120	2,56 \$
5963 3004	Zil anahtarı	120	2,56 \$
5963 3005	Komitatör	120	2,78 \$
5963 3006	Vavien	120	2,78 \$
5963 3007	Permitatör	120	3,30 \$
5963 3008	Komitatör vavien	120	3,48 \$
5963 3009	Jaluzi anahtarı	120	3,88 \$
5963 3010	Şofben anahtarı	120	5,80 \$
5963 3011	3'lü anahtar	120	5,08 \$
Priz Grubu			
5963 3014	Priz	120	2,46 \$
5963 3015	Topraklı priz	120	2,76 \$
5963 3016	Çocuk korumalı topraklı priz	120	3,38 \$
5963 3017	UPS topraklı priz	120	3,30 \$
5963 3018	UPS çocuk korumalı topraklı priz	120	3,34 \$
5963 3019	Kapaklı topraklı priz	120	3,04 \$
5963 3020	Çocuk korumalı kapaklı topraklı priz	120	3,78 \$
5963 3021	UPS kapaklı topraklı priz	120	4,68 \$
5963 3023	İkili priz	100	3,00 \$
5963 3024	İkili topraklı priz	70	3,14 \$
TV/Radyo Grubu			
5963 3030	TV priz geçişli	120	3,72 \$
5963 3031	TV priz sonlu	120	3,72 \$
5963 3032	TV priz dirençsiz	120	3,72 \$
5963 3033	Uydu prizi F konnektörlü geçişli	120	5,08 \$
5963 3034	Uydu prizi F konnektörlü sonlu	120	5,08 \$
5963 3035	TV - Radyo priz geçişli	120	8,32 \$
5963 3036	TV - Radyo priz sonlu	120	8,32 \$
5963 3037	TV - Sat priz geçişli	120	12,36 \$
5963 3038	TV - Sat priz sonlu	120	12,36 \$

Kod No	Cinsi	Koli Ad.	Onyx Metalik Seri
İletişim Grubu			
5963 3040	Telefon prizi	120	2,46 \$
5963 3041	Numeris telefon prizi (RJ11)	120	2,96 \$
5963 3042	İkili numeris (RJ11)	120	4,06 \$
5963 3043	Data numeris (RJ45CAT5-RJ11)	120	8,64 \$
5963 3044	Data priz (RJ45CAT5)	120	8,32 \$
5963 3045	İkili data priz (RJ45CAT5)	120	13,16 \$
5963 3046	Data jaksız	120	2,78 \$
5963 3047	Data priz (RJ45CAT6)	120	8,32 \$
5963 3048	İkili data priz (RJ45CAT6)	120	13,16 \$
5963 3049	Data - Numeris (RJ45CAT6-RJ11)	120	8,64 \$
5963 3050	Müzik Yayın Prizi	80	16,24 \$
5963 3052	VGA Prizi	80	25,16 \$
5963 3059	Müzik yayın anahtarı	80	11,68 \$
Dimmer Grubu			
5963 3055	Dimmer 600W	80	10,18 \$
5963 3056	Dimmer 1000W	80	9,60 \$
5963 3057	Dimmer vavien 600W	80	18,80 \$
5963 3058	Dimmer RC 300W	80	20,44 \$
Işıklı Anahtar Grubu			
5963 3070	Işıklı anahtar	120	3,20 \$
5963 3071	Işıklı light	120	3,26 \$
5963 3072	Işıklı komitatör	120	3,58 \$
5963 3073	Işıklı vavien	120	3,58 \$
5963 3074	Işıklı etiketli zil	120	3,48 \$
5963 3075	Işıklı dimmer 600W	80	10,30 \$
5963 3076	Işıklı dimmer 1000W	80	11,14 \$
5963 3077	Işıklı dimmer vavien 600W	80	17,60 \$
5963 3078	Işıklı dimmer RC 300W	80	20,84 \$
Çerçeveler			
5963 3081	2'li çerçeve yatay-dikey	200	2,04 \$
5963 3082	3'lü çerçeve yatay-dikey	150	2,30 \$
5963 3083	4'lü çerçeve yatay-dikey	50	2,72 \$
5963 3084	5'li çerçeve yatay-dikey	50	3,12 \$
5963 3085	6'lı çerçeve yatay-dikey	50	3,56 \$

Onyx Kiraz Anahtar ve Priz Serisi



Kiraz: K23

Onyx Meşe Anahtar ve Priz Serisi

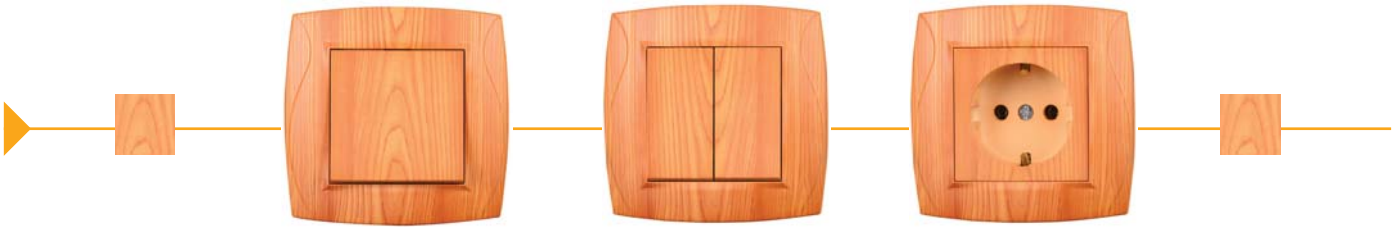

Meşe: K22

Kod No	Cinsi	Koli Ad,	Onyx Ahşap Seri
Anahtar Grubu			
5963 3001	Anahtar	120	2,58 \$
5963 3002	Light	120	3,46 \$
5963 3003	Kapı otomatiği	120	3,46 \$
5963 3004	Zil anahtarları	120	3,46 \$
5963 3005	Komitatör	120	3,78 \$
5963 3006	Vavien	120	3,78 \$
5963 3007	Permitatör	120	3,34 \$
5963 3008	Komitatör vavien	120	3,58 \$
5963 3009	Jaluzi anahtarları	120	3,94 \$
5963 3010	Şofben anahtarları	120	5,84 \$
5963 3011	3'lü anahtar	120	5,14 \$
Priz Grubu			
5963 3014	Priz	120	2,58 \$
5963 3015	Topraklı priz	120	2,88 \$
5963 3016	Çocuk korumalı topraklı priz	120	3,46 \$
5963 3017	UPS topraklı priz	120	3,34 \$
5963 3018	UPS çocuk korumalı topraklı priz	120	3,44 \$
5963 3019	Kapaklı topraklı priz	120	3,12 \$
5963 3020	Çocuk korumalı kapaklı topraklı priz	120	3,84 \$
5963 3021	UPS kapaklı topraklı priz	120	4,70 \$
5963 3023	İkili priz	100	3,10 \$
5963 3024	İkili topraklı priz	70	3,22 \$
TV/Radyo Grubu			
5963 3030	TV priz geçişli	120	3,78 \$
5963 3031	TV priz sonlu	120	3,78 \$
5963 3032	TV priz dirençsiz	120	3,78 \$
5963 3033	Uydu prizi F konnektörlü geçişli	120	5,14 \$
5963 3034	Uydu prizi F konnektörlü sonlu	120	5,14 \$
5963 3035	TV - Radyo priz geçişli	120	11,78 \$
5963 3036	TV - Radyo priz sonlu	120	11,78 \$
5963 3037	TV - Sat priz geçişli	120	12,14 \$
5963 3038	TV - Sat priz sonlu	120	12,14 \$

Kod No	Cinsi	Koli Ad,	Onyx Ahşap Seri
iletişim Grubu			
5963 3040	Telefon prizi	120	2,58 \$
5963 3041	Numeris telefon prizi (RJ11)	120	3,02 \$
5963 3042	İkili numeris (RJ11)	120	4,14 \$
5963 3043	Data numeris (RJ45CAT5-RJ11)	120	8,52 \$
5963 3044	Data priz (RJ45CAT5)	120	11,78 \$
5963 3045	İkili data priz (RJ45CAT5)	120	12,90 \$
5963 3046	Data jaksız	120	2,90 \$
5963 3047	Data priz (RJ45CAT6)	120	11,78 \$
5963 3048	İkili data priz (RJ45CAT6)	120	12,90 \$
5963 3049	Data - Numeris (RJ45CAT6-RJ11)	120	8,52 \$
5963 3050	Müzik Yayın Prizi	80	15,90 \$
5963 3052	VGA Prizi	80	24,08 \$
5963 3059	Müzik yayın anahtarları	80	11,50 \$
Dimmer Grubu			
5963 3055	Dimmer 600W	80	9,78 \$
5963 3056	Dimmer 1000W	80	10,58 \$
5963 3057	Dimmer vavien 600W	80	18,34 \$
5963 3058	Dimmer RC 300W	80	19,92 \$
Işıklı Anahtar Grubu			
5963 3070	Işıklı anahtar	120	3,24 \$
5963 3071	Işıklı light	120	3,34 \$
5963 3072	Işıklı komitatör	120	3,64 \$
5963 3073	Işıklı vavien	120	3,64 \$
5963 3074	Işıklı etiketli zil	120	3,58 \$
5963 3075	Işıklı dimmer 600W	80	10,18 \$
5963 3076	Işıklı dimmer 1000W	80	10,94 \$
5963 3077	Işıklı dimmer vavien 600W	80	17,18 \$
5963 3078	Işıklı dimmer RC 300W	80	20,30 \$
Çerçeveler			
5963 3081	2'li çerçeve yatay-dikey	200	2,16 \$
5963 3082	3'lü çerçeve yatay-dikey	150	2,40 \$
5963 3083	4'lü çerçeve yatay-dikey	50	2,84 \$
5963 3084	5'li çerçeve yatay-dikey	50	3,22 \$
5963 3085	6'lı çerçeve yatay-dikey	50	3,60 \$

Konfigürasyon: Kiraz: K23
Meşe: K22



Urla

Çocuk Korumalı Topraklı Grup Priz Serisi



Kod No	Cinsi	Koli Ad.	Urla Seri
Urla Çocuk Korumalı			
204377	3'lü 2m Çocuk Korumalı	48	4,68 \$
204379	3'lü 3m Çocuk Korumalı	48	5,44 \$
204381	3'lü 5m Çocuk Korumalı	24	7,00 \$
Urla Çocuk Korumalı			
204383	5'li 2m Çocuk Korumalı	36	6,72 \$
204385	5'li 3m Çocuk Korumalı	36	7,48 \$
204387	5'li 5m Çocuk Korumalı	24	9,08 \$
Urla Anahtarlı Çocuk Korumalı			
204378	3'lü Anahtarlı 2m Çocuk Korumalı	48	6,08 \$
204380	3'lü Anahtarlı 3m Çocuk Korumalı	48	6,84 \$
204382	3'lü Anahtarlı 5m Çocuk Korumalı	24	8,42 \$
Urla Anahtarlı Çocuk Korumalı			
204384	5'li Anahtarlı 2m Çocuk Korumalı	36	8,14 \$
204386	5'li Anahtarlı 3m Çocuk Korumalı	36	8,88 \$
204388	5'li Anahtarlı 5m Çocuk Korumalı	24	10,50 \$

UPS

Grup Priz Serisi



Kod No	Cinsi	Koli Ad.	UPS Seri
UPS Çeşme			
204136	3'lü UPS Serisi Priz (klemensli)	100	2,76 \$
204133	3'lü UPS Serisi Priz (2m)	36	4,94 \$
204134	3'lü UPS Serisi Priz (3m)	36	5,72 \$
204135	3'lü UPS Serisi Priz (5m)	24	7,28 \$
UPS Çeşme			
204140	4'lü UPS Serisi (klemensli)	100	4,22 \$
204137	4'lü UPS Serisi Priz (2m)	36	6,38 \$
204138	4'lü UPS Serisi Priz (3m)	36	7,16 \$
204139	4'lü UPS Serisi Priz (5m)	24	8,72 \$
UPS Çeşme			
204144	6'li UPS Serisi Priz (klemensli)	100	5,50 \$
204141	6'li UPS Serisi Priz (2m)	36	7,68 \$
204142	6'li UPS Serisi Priz (3m)	36	8,44 \$
204143	6'li UPS Serisi Priz (5m)	24	10,00 \$
UPS Foça Anahtarlı			
204373	5'li UPS Serisi Priz (klemensli)	100	6,58 \$
204370	5'li UPS Serisi Priz (2m)	36	8,76 \$
204371	5'li UPS Serisi Priz (3m)	36	9,52 \$
204372	5'li UPS Serisi Priz (5m)	24	11,10 \$

Çeşme

Grup Priz Serisi



Kod No	Cinsi	Koli Ad.	Çeşme Serisi
203790	2'li klemensli	100	1,82 \$
203794	3'lü klemensli	100	2,20 \$
203798	4'lü klemensli	100	3,44 \$
203802	5'li klemensli	100	4,18 \$
203806	6'lı klemensli	100	4,38 \$
203787	2'li 2 m kablolu	48	4,00 \$
203791	3'lü 2 m kablolu	48	4,38 \$
203795	4'lü 2 m kablolu	36	5,62 \$
203799	5'li 2 m kablolu	36	6,36 \$
203803	6'lı 2 m kablolu	36	6,56 \$
203788	2'li 3 m kablolu	48	4,74 \$
203792	3'lü 3 m kablolu	48	5,16 \$
203796	4'lü 3 m kablolu	36	6,38 \$
203800	5'li 3 m kablolu	36	7,12 \$
203804	6'lı 3 m kablolu	36	7,34 \$
203789	2'li 5 m kablolu	24	6,36 \$
203793	3'lü 5 m kablolu	24	6,72 \$
203797	4'lü 5 m kablolu	24	7,94 \$
203801	5'li 5 m kablolu	24	8,72 \$
203805	6'lı 5 m kablolu	24	8,88 \$

Foça

Anahtarlı Grup Priz Serisi



Kod No	Cinsi	Koli Ad.	Foça Serisi
204353	2'li klemensli anahtarlı	100	3,24 \$
204357	3'lü klemensli anahtarlı	100	3,64 \$
204361	4'lü klemensli anahtarlı	100	4,86 \$
204365	5'li klemensli anahtarlı	100	5,62 \$
204369	6'lı klemensli anahtarlı	50	5,80 \$
204350	2'li 2 m kablolu anahtarlı	48	5,42 \$
204354	3'lü 2 m kablolu anahtarlı	48	5,80 \$
204358	4'lü 2 m kablolu anahtarlı	36	7,02 \$
204362	5'li 2 m kablolu anahtarlı	36	7,76 \$
204366	6'lı 2 m kablolu anahtarlı	36	7,96 \$
204351	2'li 3 m kablolu anahtarlı	48	6,18 \$
204355	3'lü 3 m kablolu anahtarlı	48	6,58 \$
204359	4'lü 3 m kablolu anahtarlı	36	7,80 \$
204363	5'li 3 m kablolu anahtarlı	36	8,52 \$
204367	6'lı 3 m kablolu anahtarlı	36	8,76 \$
204352	2'li 5 m kablolu anahtarlı	24	7,76 \$
204356	3'lü 5 m kablolu anahtarlı	24	8,14 \$
204360	4'lü 5 m kablolu anahtarlı	24	9,36 \$
204364	5'li 5 m kablolu anahtarlı	24	10,14 \$
204368	6'lı 5 m kablolu anahtarlı	24	10,30 \$

Gerilim Korumalı Topraklı Grup Priz



Aksesuarlar

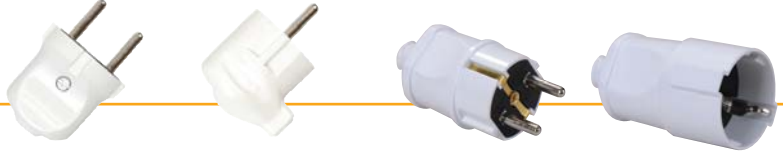

Fişler



Uzatma



Kod No	Cinsi	Koli Ad.	Fiş Prizler Serisi
204147	6'lı 2metre gerilim korumalı siyah	20	12,46 \$

Kod No	Cinsi	Koli Ad.	Aksesuar Serisi
204395	Erkek fiş	1000	2,38 \$
204396	Topraklı erkek fiş	500	2,92 \$
204397	Topraklı dişi fiş	250	2,38 \$
204402	Topraklı erkek fiş L tipi	500	0,56 \$

Kod No	Cinsi	Koli Ad.	Fiş Prizler Serisi
204401	3'lü grup fiş priz	100	0,66 \$
204400	4'lü kare fiş priz	100	0,68 \$
204399	Trio fiş priz	100	0,66 \$

Kod No	Cinsi	Koli Ad.	Uzatma Kabloları Serisi
204130	3 metre uzatma (3x1 mm)	50	5,68 \$
204131	5 metre uzatma (3x1 mm)	50	7,70 \$
204128	10 metre uzatma (3x1 mm)	25	14,76 \$

Dekart
Dekoratif Sarkıt

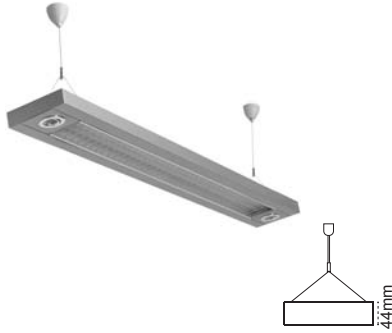

IP 20 

Kod No	Özellikler	Koli Adedi	Fiyat
	2X28W T5	1	90,00 \$

Menart
Dekoratif Sarkıt



IP 20 

Kod No	Özellikler	Koli Adedi	Fiyat
105084	2X28W T5	1	53,00 \$

Artemis
Dekoratif Sarkıt



IP 40 

Kod No	Özellikler	Koli Adedi	Fiyat
105080	3X35W T5	1	100,00 \$

Planet
Tavan Armatürü



IP 20 

Ø460



Lamba Dahil 

Kod No	Özellikler	Koli Adedi	Fiyat
204117	1X55W	1	28,30 \$

Popart
Tavan Armatürü



IP 20 

410mm



Lamba Dahil 

Kod No	Özellikler	Koli Adedi	Fiyat
204126	1X55W	1	28,30 \$

Miro S
Tavan Armatürü



IP 40 

260mm

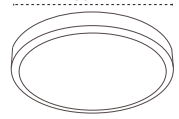

Kod No	Özellikler	Koli Adedi	Fiyat
204094	2XE27	12	25,00 \$

Polo
Tavan Armatürü



Polo 2

190mm

130mm

Polo 4

Ø281

131mm

IP 44 

Kod No	Özellikler	Koli Adedi	Fiyat
204561	Polo 2 E27	8	18,90 \$
204562	Polo 4 E27	8	19,00 \$

Hisar
Tavan Armatürü



IP 65 

270mm

135mm

Kod No	Özellikler	Koli Adedi	Fiyat
203963	2xE27	6	25,00 \$

Dossi
Tavan Armatürü



IP 40 

290mm

290mm

Kod No	Özellikler	Koli Adedi	Fiyat
203865	16W LEDli 6500K	3	35,80 \$

Piero 2
Dekoratif Aplik



IP 20 

Ø110

162mm

Kod No	Özellikler	Koli Adedi	Fiyat
204557	2xG9	12	17,00 \$

Piero 4
Dekoratif Sarkıt



IP 20 

120mm

680mm

Kod No	Özellikler	Koli Adedi	Fiyat
204558	4xG9	4	45,00 \$

Costa 2
Dekoratif Aplik



IP 20 

Ø168

129mm

Kod No	Özellikler	Koli Adedi	Fiyat
204540	2xGU10	2	15,85 \$

24 LEDli Bahçe Feneri



IP 20

Kod No	Özellikler	Koli Adedi	Fiyat
204646	24 LEDli Kırmızı	10	12,70 \$
204645	24 LEDli Beyaz	10	12,70 \$

24+6 LEDli Işıldak

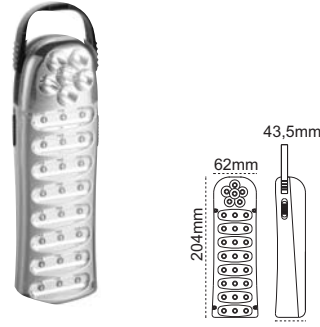

IP 20

Kod No	Özellikler	Koli Adedi	Fiyat
204618	24+6 LEDli	60	7,60 \$

16 LEDli El Feneri



IP 20

Kod No	Özellikler	Koli Adedi	Fiyat
204655	16 LEDli	30	11,80 \$

9 LEDli El Feneri



IP 20

Kod No	Özellikler	Koli Adedi	Fiyat
204651	9 LEDli Gümüş	128	2,55 \$
204650	9 LEDli Bordo	128	2,55 \$
204652	9 LEDli Krom	128	2,55 \$
204653	9 LEDli Siyah	128	2,55 \$

4+1 LEDli Çakılı El Feneri



IP 40

Kod No	Özellikler	Koli Adedi	Fiyat
204647	4+1 LEDli	50	4,50 \$

Ufo Acil Aydınlatma Spotu



IP 40

Kod No	Özellikler	Koli Adedi	Fiyat
204463	3W 3000K	20	56,60 \$

Duvar Gömme



IP 44

Kod No	Özellikler	Koli Adedi	Fiyat
204436	E27	18	8,50 \$

Netled Duvar Gömme

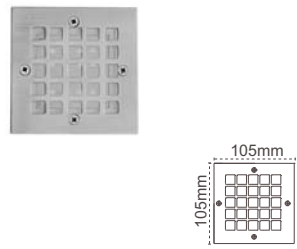

IP 65

Kod No	Özellikler	Koli Adedi	Fiyat
204450	LEDli Mavi	20	20,00 \$
204720	Mavi	20	11,50 \$

Kepled Duvar Gömme



IP 44

Kod No	Özellikler	Koli Adedi	Fiyat
204448	LEDli Mavi	18	14,80 \$

Clubled Aplik

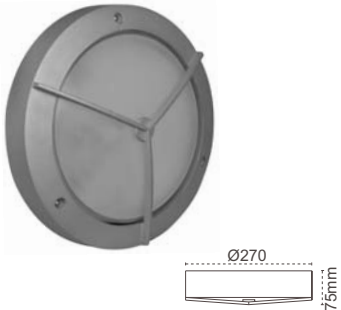

IP 44

Kod No	Özellikler	Koli Adedi	Fiyat
204528	LEDli Beyaz	40	9,50 \$
204527	LEDli Mavi	40	9,50 \$
204526	LEDli Beyaz	40	9,50 \$

Hatled Duvar Gömme

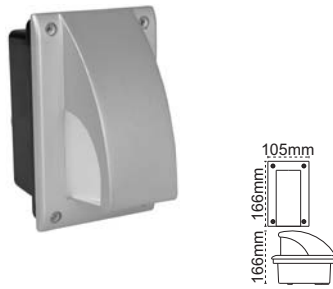

IP 44

Kod No	Özellikler	Koli Adedi	Fiyat
204531	LEDli Beyaz	12	14,00 \$
204530	LEDli Mavi	12	14,00 \$

Perle Duvar Aplik



IP 44

Kod No	Özellikler	Koli Adedi	Fiyat
204525	Aplik E27	20	10,00 \$

Yer Gömme 20

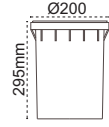

IP 65 ☺

Kod No	Özellikler	Koli Adedi	Fiyat
204264	Yer Gömme 20 Boş	1	31,00 \$
105737	Yer Gömme 12X1W LEDli	1	162,80 \$

Yer Gömme 25

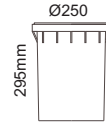

IP 65 ☺

Kod No	Özellikler	Koli Adedi	Fiyat
204265	Yer Gömme Asimetrik G12 Boş	1	90,00 \$

Yer Gömme Kare Asimetrik

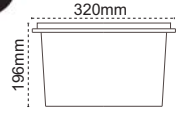

IP 65 ☺

Kod No	Özellikler	Koli Adedi	Fiyat
107648	RX7s	10	90,00 \$

Midiled 12 Yuvarlak Yer Gömme

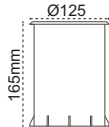

IP 65 ☺

Kod No	Özellikler	Koli Adedi	Fiyat
204273	LEDli 4000K	18	89,00 \$

Midiled 12 Kare Yer Gömme



IP 65 ☺

Kod No	Özellikler	Koli Adedi	Fiyat
204275	LEDli Mavi	18	25,60 \$

Miniled 3'lü Yer Gömme

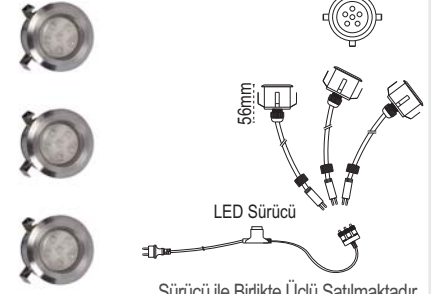

IP 65 ☺

Kod No	Özellikler	Koli Adedi	Fiyat
204266	LEDli Mavi	12	25,00 \$

Teak Aplık

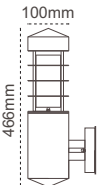

IP 44 ☺

Kod No	Özellikler	Koli Adedi	Fiyat
204510	Aplık E27	1	55,00 \$
204425	Set Üstü E27	1	45,00 \$

Işıglas Aplık

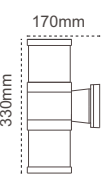

IP 44 ☺

Kod No	Özellikler	Koli Adedi	Fiyat
204507	1 Aplık E27	12	22,00 \$
204508	2 Aplık 2XE27	8	30,00 \$
204429	E27 Çimen Armatürü	4	40,00 \$

Corona Aplık/Bolard



IP 54 ☺

Kod No	Özellikler	Koli Adedi	Fiyat
204516	Aplık 6W 3000K	1	55,00 \$
204467	Bolard 6W 3000K	1	100,00 \$

Lilyum 2'li Direk



2100mm

710mm

IP 54 ☺

Kod No	Özellikler	Koli Adedi	Fiyat
203862	2XE27	1	175,45 \$

Açelya 3'lü Direk



2040mm

685mm

IP 54 ☺

Kod No	Özellikler	Koli Adedi	Fiyat
203861	3XE27	1	157,90 \$

Verde & Sparta



4500mm

560mm

4500mm

710mm

IP 65 ☺

Kod No	Özellikler	Koli Adedi	Fiyat
204246	Verde LEDli 68W 6500K	1	945,00 \$
104372	Sparta MH 150W E40	1	285,00 \$

Briled 1
Aplik

Alüminyum
Gövde

160mm

IP 54

Kod No	Özellikler	Koli Adedi	Fiyat
204524	5W LEDli 4000K	6	21,00 \$

Briled 2
Aplik

Alüminyum
Gövde

250mm

IP 54

Kod No	Özellikler	Koli Adedi	Fiyat
204523	2x5W LEDli 4000K	6	26,00 \$

Briled 3
Çimen
Armatürü

Alüminyum
Gövde

60mm
600mm

IP 54

Kod No	Özellikler	Koli Adedi	Fiyat
203812	5W LEDli 4000K	6	39,00 \$

Mezzo
Aplik

Alüminyum
Enjeksiyon

360mm
90mm

IP 54

Kod No	Özellikler	Koli Adedi	Fiyat
204518	6W LED 3000K	6	47,30 \$
204521	6W LED 3000K	10	51,60 \$

Verso
Aplik

Alüminyum
Enjeksiyon

130mm
220mm

IP 54

Kod No	Özellikler	Koli Adedi	Fiyat
204522	E27	8	47,80 \$
204519	6W LED 3000K	12	56,80 \$

Rayo
Set Üstü

Alüminyum
Enjeksiyon

190mm
235mm

IP 54

Kod No	Özellikler	Koli Adedi	Fiyat
204424	E27	8	71,50 \$

Grassled
Çimen Armatürü

Alüminyum
Enjeksiyon

115mm
311mm

IP 65

Kod No	Özellikler	Koli Adedi	Fiyat
203813	3W 6500K	20	17,00 \$
203816	3W Yeşil	20	17,00 \$
203814	Saplama Aparatı	1	7,00 \$

İşiled 2

141mm
65mm

IP 44

Kod No	Özellikler	Koli Adedi	Fiyat
204473	LEDli Ilık Beyaz	24	12,00 \$
204472	LEDli Mavi	24	12,00 \$

İşiled 3

60mm
65mm
160mm

IP 44

Kod No	Özellikler	Koli Adedi	Fiyat
204474	LEDli Mavi	12	12,00 \$

Dora LED
Aplik

Alüminyum
Enjeksiyon

60mm
80mm
40mm

IP 44

Kod No	Özellikler	Koli Adedi	Fiyat
204529	3W 4000K	24	39,00 \$

Doris
Havuz Armatürü
12V

Ø228
59mm

IP 65

Kod No	Özellikler	Koli Adedi	Fiyat
204459	36W RGB	3	75,00 \$
204458	36W 6500K	3	75,00 \$

LEDli Gömme
Havuz Armatürü
24V

Alüminyum
Enjeksiyon

Ø360mm
150mm

IP 68

Kod No	Özellikler	Koli Adedi	Fiyat
204455	Havuz Armatürü 12x1W RGB	1	102,00 \$
313699	60W 24V Güç Kaynağı	1	75,00 \$
313701	100W 24V Güç Kaynağı	1	75,00 \$

Euro 1000W Simetrik 
Alüminyum Enjeksiyon

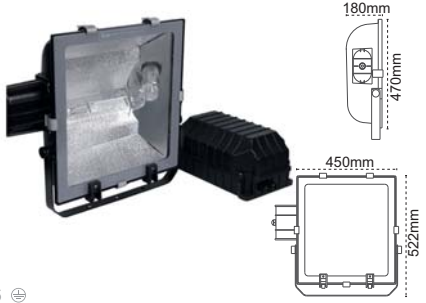

IP 65

Kod No	Özellikler	Koli Adedi	Fiyat
203884	1000 W Metal, HPI-T	1	378,00 \$

Bolivo Projektör
Asimetrik



IP 65

Kod No	Özellikler	Koli Adedi	Fiyat
203784	1000W E40 MH/SB	1	380,00 \$

Krono Projektör
Asimetrik

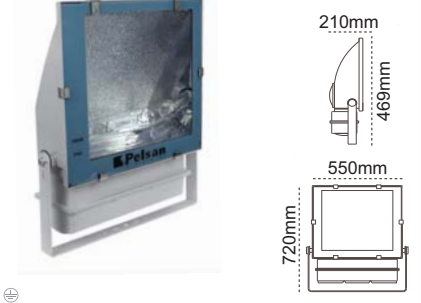

IP 65

Kod No	Özellikler	Koli Adedi	Fiyat
105210	1000W E40 MH/SB	1	350,00 \$

Shekelo Projektör

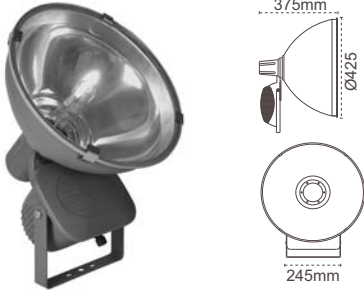

IP 65

Kod No	Özellikler	Koli Adedi	Fiyat
204165	Shekelo E40 Boş	1	108,00 \$
105229	Shekelo 250W E40 MH/SB	1	180,00 \$
105232	Shekelo 400W E40 MH/SB	1	113,00 \$

Pole Projektör
Simetrik

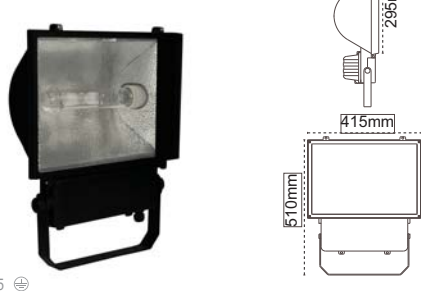

IP 65

Kod No	Özellikler	Koli Adedi	Fiyat
105145	Pole 400W E40 MH	1	73,00 \$
			130,00 \$

Pesato Projektör
Asimetrik

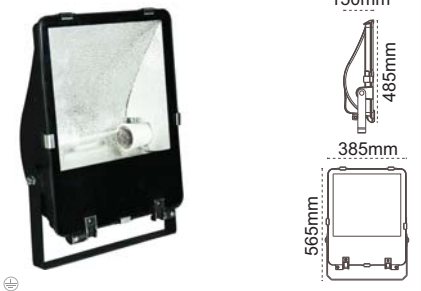

IP 65

Kod No	Özellikler	Koli Adedi	Fiyat
204149	400W E40 Boş	1	78,00 \$

Tünel 250-400W
Alüminyum Enjeksiyon

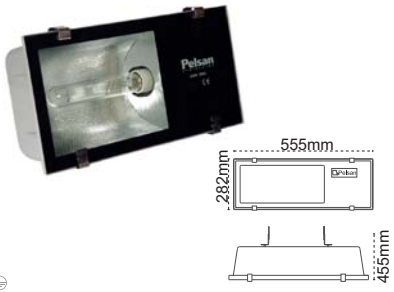

IP 65

Kod No	Özellikler	Koli Adedi	Fiyat
104327	250W MH/SB E40	1	147,00 \$
203575	400W SB E40	1	147,00 \$

Leyo
Alüminyum Enjeksiyon



IP 65

Kod No	Özellikler	Koli Adedi	Fiyat
107758	25W Levo LED	4	108,00 \$

RGB Projektör
36 LEDli

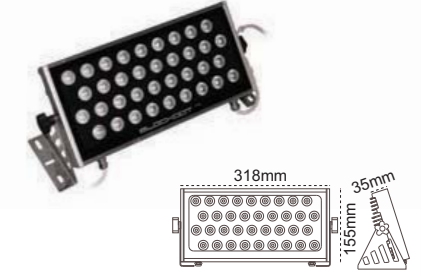

IP 65

Kod No	Özellikler	Koli Adedi	Fiyat
204723	RGB Projektör 36 LEDli	1	167,70 \$

S.A. Wallwasher



IP 65

Kod No	Özellikler	Koli Adedi	Fiyat
204254	xxx	1	100,00 \$
204255	xxx	1	189,00 \$
204256	xxx	1	378,00 \$

Wallwasher
18 LEDli

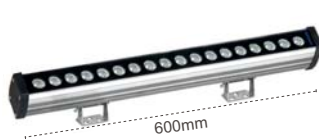

IP 65

Kod No	Özellikler	Koli Adedi	Fiyat
105417	18 LEDli 50cm Amber	1	30,00 \$

Wallwasher
30 LEDli

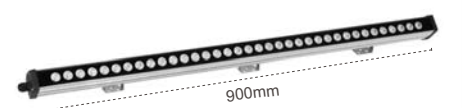

IP 65

Kod No	Özellikler	Koli Adedi	Fiyat
105445	30 LEDli 80cm 6500K	1	50,00 \$

Delta Ray Spot

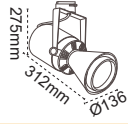

IP 44

Kod No	Özellikler	Koli Adedi	Fiyat
203825	G12	6	39,60 \$

Zeta Ray Spot

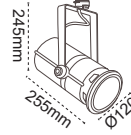

IP 44

Kod No	Özellikler	Koli Adedi	Fiyat
204291	G12	8	14,15 \$

Beta Ray Spot

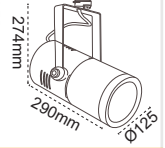

IP 44

Kod No	Özellikler	Koli Adedi	Fiyat
203783	G12	8	32,50 \$

Kappa LED Ray Spot

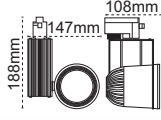

IP 44

Kod No	Özellikler	Koli Adedi	Fiyat
107759	30W 3000K	8	62,10 \$

Theta LED Ray Spot

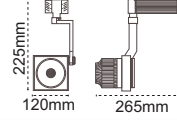

IP 44

Kod No	Özellikler	Koli Adedi	Fiyat
204319	23W 4000K	12	45,00 \$

Divya Ray Spot

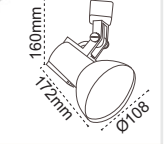

IP 44

Kod No	Özellikler	Koli Adedi	Fiyat
203958	Par30 E27	20	15,00 \$

Stella

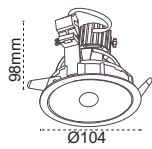

IP 20

Kod No	Özellikler	Koli Adedi	Fiyat
204659	GX5,3	50	6,30 \$

G12 Kompakt Metal

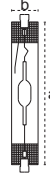

axbmm
70W G12: 89x22,5
150W G12: 99x22,5

Kod No	Özellikler	Koli Adedi	Fiyat
313519	70W 5500K G12	100	12,10 \$
313521	70W 3000K G12	100	12,10 \$
313522	150W 3000K G12	100	13,30 \$

Rx7S Kompakt Metal

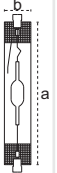

axbmm
70W Rx7s: 116x22,5
150W Rx7s: 137x23,5

Kod No	Özellikler	Koli Adedi	Fiyat
313511	70W 5500K Rx7s	100	10,40 \$
313515	150W 5500K Rx7s	100	10,40 \$

Par38 LED Lamba

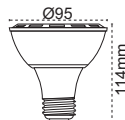

Kod No	Özellikler	Koli Adedi	Fiyat
313408	12X1W 4000K E27	20	10,40 \$
313409	12X1W 4000K E27	20	10,40 \$

3x1W MR16

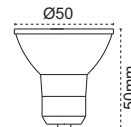

Kod No	Özellikler	Koli Adedi	Fiyat
313388	3X1W 3000K GU5,3	200	1,60 \$

24W LED Lamba

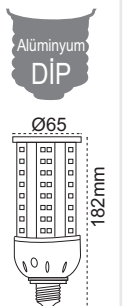

Kod No	Özellikler	Koli Adedi	Fiyat
313418	24W 6500K E27	25	47,00 \$

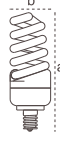

Maxin Spiral

axbmm
12W : 92x40
14W : 105x40

Kod No	Özellikler	Koli Adedi	Fiyat
313500	12W E14 2700K	100	1,15 \$
313481	14W E14 2700K	100	1,15 \$

Maxin Spiral

axbmm
9W : 105x40

Kod No	Özellikler	Koli Adedi	Fiyat
313480	9W G9 2700K	100	1,15 \$

Maxin Spiral

axbmm
45W : 230x75
65W : 242x75

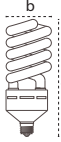
Kod No	Özellikler	Koli Adedi	Fiyat
313490	45W E27 2700K	25	5,30 \$
313503	65W E27 2700K	25	7,10 \$

18W T8



25mm 1214mm

Kod No	Özellikler	Koli Adedi	Fiyat
313380	18W T8 Floresan 12000K	25	0,83 \$



35W T5



16mm 548mm

Kod No	Özellikler	Koli Adedi	Fiyat
313367	35W T5 Floresan 4000K	100	3,10 \$

PLC Lamba

27mm 154mm

Kod No	Özellikler	Koli Adedi	Fiyat
313340	26W PLC 4000K 4 Pinli	100	1,00 \$
313339	18W PLC 4000K 4 Pinli	100	1,00 \$
313334	18W PLC 6400K	100	1,00 \$
313337	13W PLC 6400K	100	1,00 \$

Mare Beyaz Dikey Downlight



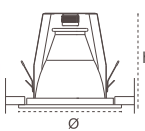

Øxhmm
3" : 124x145
5" : 174x182
6" : 115x221

IP 20 ⊕

Kod No	Özellikler	Koli Adedi	Fiyat
204039	3" E27 Boş	50	2,50 \$
204040	5" E27 Boş	20	3,50 \$
204042	6" E27 Boş	20	4,50 \$

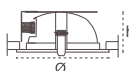
Mare Beyaz Yatay Downlight

Øxh
6" : 190x100mm
8" : 240x120mm

IP 20 ⊕

Kod No	Özellikler	Koli Adedi	Fiyat
204046	6" Y2 E27 Boş	20	6,00 \$
203125	8" Y2 E27 Boş	12	9,00 \$

Mare Beyaz Yatay Downlight



Øxh
8" : 240x120mm

IP 20 ⊕

Kod No	Özellikler	Koli Adedi	Fiyat
204035	8" Y2 E27 Boş	20	9,50 \$

Sarin Downlight Camsız





Øxhmm
5" : 174x182
8" : 182x221

IP 20 ⊕

Kod No	Özellikler	Koli Adedi	Fiyat
204162	5" E27 Camsız	20	4,80 \$
204164	8" G24 Camsız	12	8,30 \$

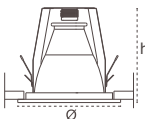
Sarin Downlight Camlı

Øxhmm
2" : 97x133
3" : 124x145
6" : 115x221

IP 20 ⊕

Kod No	Özellikler	Koli Adedi	Fiyat
204158	2" Y2 G24 Camlı Boş	50	2,50 \$
203359	3" Y2 G24 Camlı Boş	50	6,00 \$
204160	6" Y2 G24 Camlı Boş	20	10,00 \$

Sorto Downlight



Ø182 174mm

IP 20 ⊕

Kod No	Özellikler	Koli Adedi	Fiyat
204240	5" G24 Boş	20	8,00 \$
204242	6" Y1 G24 Boş	20	10,00 \$
203483	8" Y1 G24 Boş	12	10,50 \$

Kod No	Yeni Kod No	Sayfa	Sıra	Kod No	Yeni Kod No	Sayfa	Sıra	Kod No	Yeni Kod No	Sayfa	Sıra	Kod No	Yeni Kod No	Sayfa	Sıra	Kod No	Yeni Kod No	Sayfa	Sıra
5918 2650	313257	80	4	5984 5010	313504	77	1	5985 5740	313527	10	5	108266	24	1		108360	32	5	
5918 2660	313258	80	4	5984 5020	313505	77	1	5985 9340	313699	98	12	108256	24	1		108468	32	6	
5921 1711	313323	83	1	5984 5030	313506	77	1	5985 9360	313701	98	12	108268	24	2		108359	32	6	
5921 1721	313324	83	2	5984 5040	313507	77	1	5985 9810	313768	64	3	108267	24	2		108464	33	4	
5921 1731	313325	83	3	5984 5050	313508	77	2	5999 5071	107758	56	8	108270	24	3		108466	33	5	
5921 1741	313326	83	4	5984 5060	313509	77	2	5999 5071	107758	99	8	108269	24	3		108465	33	6	
5951 6260	204672	38	2	5984 5070	313510	77	2	5999 5080	107759	100	4	108272	24	4		108118	40	1	
5951 6260	204672	46	5	5984 6010	313511	77	5	107966	6	3		108271	24	4		108119	40	1	
5951 6270	204673	38	2	5984 6010	313511	100	9	107967	6	3		204207	24	5		108120	40	2	
5951 6270	204673	46	5	5984 6020	313512	77	4	107968	6	4		204211	24	5		108407	40	2	
5951 6280	204671	38	2	5984 6070	313513	77	3	107969	6	4		204183	24	5		108519	41	1	
5951 6280	204671	46	5	5984 6080	313514	77	4		6	5		108325	24	6		311186	42	3	
5980 1120	313334	101	6	5984 6110	313515	77	5		6	5		108328	24	6		108526	47	1	
5980 1430	313337	101	6	5984 6510	313519	77	5		6	5		108327	24	6		108524	47	1	
5980 1530	313339	101	6	5984 6510	313519	100	8	108089	7	1		108316	26	3		108532	47	1	
5980 1540	313340	101	6	5984 6520	313520	77	5	108104	7	2		108317	26	3		108534	47	1	
5980 6060	313367	101	5	5984 6540	313521	77	5	108087	7	3		108312	26	4		108527	47	2	
5980 8420	313380	101	4	5984 6540	313521	100	8	108088	7	4		108310	26	4		108525	47	2	
5981 1120	313383	77	7	5984 6550	313522	77	5	315382	7	5		108344	26	6		108533	47	2	
5981 1170	313384	77	8	5984 6550	313522	100	8	315898	7	5		108151	26	6		108535	47	2	
5981 1310	313387	77	8	5984 6560	313523	77	3	108114	8	1		303839	27	6		108225	47	3	
5981 1320	313388	77	8	5985 1030	203730	79	2	108116	8	2		303840	27	6		108372	47	3	
5981 1320	313388	100	11	5985 1040	203731	79	2	108419	8	3		303841	27	6		108373	47	3	
5981 2530	313395	74	5	5985 1050	203733	79	2	106060	8	3		303842	27	6			48	4	
5981 2540	313396	74	5	5985 1060	203734	79	2	108418	8	3		303843	27	6			48	5	
5981 2650	315106	74	1	5985 1070	203732	79	2	108252	8	4		316068	27	6		107929	49	1	
5981 2660	315105	74	1	5985 1080	203729	79	2	108152	9	1		303844	27	6		108297	51	1	
5981 2680	313406	74	1	5985 2510	203694	78	2	108161	9	2		316069	27	6		108298	51	1	
5981 2690	313407	74	1	5985 2520	203699	78	2	108162	9	3		303845	27	5		108458	51	1	
5981 2710	313408	77	6	5985 2530	203696	78	2	108153	9	4		303846	27	5		108459	51	1	
5981 2710	313408	100	10	5985 2540	203700	78	2	108417	10	1		303847	27	5		107105	54	1	
5981 2720	313409	77	6	5985 2550	203697	78	2	105659	10	1		303848	27	5		107103	54	2	
5981 2720	313409	100	10	5985 2560	203695	78	2	105679	10	1		303849	27	5		107101	54	3	
5981 2790	313415	74	2	5985 2570	203698	78	2	108420	10	2		316066	27	5		108166	54	3	
5981 2840	313418	76	5	5985 3210	203687	78	1	108471	10	2		303835	27	5		108167	54	3	
5981 2840	313418	100	12	5985 3220	203692	78	1	108470	10	2		316067	27	5		108438	58	1	
5981 2860	313420	76	3	5985 3230	203689	78	1	108423	10	3		204175	28	6		108012	59	3	
5981 2870	313421	76	4	5985 3240	203693	78	1	108303	10	3		204174	28	6		107770	59	3	
5981 2880	313422	76	4	5985 3250	203690	78	1	108478	10	3		108454	29	1		108160	59	5	
5981 2920	313424	77	7	5985 3260	203688	78	1	108425	10	4		108456	29	1		108159	59	5	
5981 3010	313425	76	6	5985 3270	203691	78	1	108480	10	4		204551	29	2		108079	59	5	
5981 4010	313426	74	3	5985 4010	203722	79	1	108479	10	4		204544	29	3		315173	77	7	
5981 4050	315107	74	4	5985 4020	203719	79	1		10	6		204547	29	4		204801	78	6	
5982 2020	313435	75	2	5985 4030	203720	79	1		10	6		204569	29	5		314833	78	6	
5982 2030	313436	75	2	5985 4040	203723	79	1		10	6		108273	32	1		314834	78	6	
5982 2040	313437	75	1	5985 4050	203717	79	1	100141	11	4		108279	32	1		314835	78	6	
5982 2050	313438	75	3	5985 4060	203718	79	1	106191	11	8		108276	32	1		314836	78	6	
5982 2060	313439	75	1	5985 4070	203721	79	1	108462	12	1		108361	32	1		204254	99	10	
5982 2070	313440	75	6	5985 4080	203728	79	1	108511	12	1		108362	32	1		204255	99	10	
5982 2080	313441	75	4	5985 4090	203724	79	1	108384	12	3		108367	32	2		204256	99	10	
5982 2090	313442	75	5	5985 4110	203726	79	1	108482	12	5		108368	32	2		204035	101	9	
5982 2120	313444	75	3	5985 4120	203727	79	1	108483	12	5		108277	32	2					
5982 2130	313445	75	1	5985 4130	203725	79	1	108510	12	6		108369	32	2					
5982 2140	313446	75	1	5985 5180	314663	76	1	108481	12	7		108370	32	2					
5983 1410	313459	74	6	5985 5190	314664	76	1	108408	13	1		108363	32	3					
5983 1420	313460	74	6	5985 5210	314665	76	1	106854	14	3		108364	32	3					
5983 1430	313461	74	6	5985 5220	314666	76	1	106697	14	5		108278	32	3					
5984 2210	313480	101	2	5985 5250	314668	76	2	106707	14	5		108365	32	3					
5984 2700	313481	101	1	5985 5260	314669	76	2	106716	14	9		108366	32	3					
5984 3280	313490	101	3	5985 5290	314671	76	2	108152	17	1		108467	32	4					
5984 3540	313500	101	1	5985 5710	313524	6	6	108538	19	3		108358	32	4					
5984 3640	313503	101	3	5985 5730	313526	6	6	108539	19	4		108469	32	5					

ATEX Belgesi

IEP ENERGY PETROLEUM INSTITUTE

IEP ATEX

(1) **EU- Internal Production Control Certificate**

(2) **Equipment or Protective Systems Intended for use in Potentially Explosive Atmospheres**

Directive 2014/34/EU

(3) EU – Internal Production Control Certificate Number: IEP 16 ATEX 0468

(4) Product: **Led lighting fixtures, Pelsan xy series**

(5) Firm Name: **PELSAN AYDINLATMA SANAYİ ve TİCARET A.Ş.**

(6) Firm Address: **İmce Sanayi Sitesi A Blok 101 Sokak No:38 Dudullu Ümraniye - İSTANBUL, TÜRKİYE**

(7) This product any of acceptable variation thereto is specified in the schedule to this certificate and the documents therein referred to.

(8) The IEP Ulaştırarak Enerji Petrol Gözetim , Sertifikasyon ve Teknik Hizmetler Organizasyonu Tic. Ltd. Sti., notified body number 2284 in accordance with Article 17 of the Directive 2014/34/EU of European Parliament and of the Council, dated 26 February 2014, certifies that this product has been found to comply with the Essential Health and Safety Requirements relating to the design and construction of products intended for use in potentially explosive atmospheres, given in Annex IV/III to the Directive. The examination and test results are recorded in confidential Report Nr: IEP-Rp-Ex-10-1037 date 18.11.2016.

(9) Compliance with Essential Health and safety requirements has been assured by compliance with ;

EN 60079-0 : 2012, EN 60079-15 : 2010, EN 60079-31 : 2009

(10) If the sign "X" is placed after the certificate number, it indicates that the product is subject to Specified Conditions of Safe Use specified in the schedule to this certificate.

(11) This EU-Internal Production Control Certificate relates only to the design and construction of the specified product in accordance to the directive 2014/34/EU. Further requirements of the directive apply to the manufacturing process and supply of this product. These are not covered by this certificate. Validity date 10 year. If standard or product change, this certificate is invalid.

(12) The marking of the equipment or protective system shall include the following :

II 3G Ex nR IIC T5 Ge
II 3D Ex tc IIIC (T 95 °C) De

Responsible Person :
Nurgün Terzioğlu
Head of Certification Body

Date of Issue : **22.11.2016**

IEP Ulaştırarak Enerji Petrol Göz. Sertifikasyon ve Teknik Hiz. Org. Tic. Ltd. Sti.
57461 Sok. No:3 K:2 Bornova - İZMİR, TÜRKİYE
Tel : +90 232 431 17 45 - 46 Fax : +90 232 431 17 30 E-mail: info@iep.com.tr Fr: 65
This certificate is granted subject to the general conditions of the IEP Energy Petroleum Institute. This certificate may only be reproduced in its entirety and without any change, schedule included. You can check accuracy of this document by www.iep.com.tr

Page | 1 / 2

IEP ENERGY PETROLEUM INSTITUTE

(13) Schedule

(14) Certificate Nr: **IEP 16 ATEX 0468**

(15) Description of Equipment Protective System;

The Led lighting fixtures, Pelsan xy series designed as an floodlights, high bay and canopy are mounting type of electrical device. Led lighting fixtures, Pelsan xy series made from according to Aluminium. Led lighting fixtures, Pelsan xy series is equipped with cable gland d or e type. To must be used of ground cable 4 mm² (min) and HD 21.13.S1/HD.22.4.S4 Led lighting fixtures have been evaluated in the contents of IP 66. Led lighting fixtures use as zone 2 and 22 that be used danger area determined in the EN 60079-10-1 and EN 60079-10-2 standard.

Technical Parameters: Led lighting fixtures, Pelsan xy series

Type	Power (W)
Pirroliz	50, 75, 100, 125, 150
Sia	50, 75, 100, 125, 150
Nairo	50, 75, 100, 125, 150

Operating Voltage 230 V.A.C. - 50 / 60 Hz.
Operating Temperature (-20 - +50) °C

Led lighting fixtures Product Code System

Pelsan X Y

Power (50, 75, 100, 125, 150)

Model; Pirroliz , Sia, Nairo (Accessory)

Mark

(16) This certificate is in the contents of standards that mentioned in item [9] It has been accepted that Led lighting fixtures is manufactured according to the producer instructions and the standards mentioned above.

(17) Information's of mounting instruction manual of 4 pages approved and date 08.02.2016.

(18) List of Documentation;

Drawing Nr ;	Drawing Name ;	Date ;
PLS-01	Frame	25.01.2016
PLS-02	Body Aluminum	25.01.2016
PLS-03	Plastic Driver Cover	25.01.2016
PLS-04	Screw Cross Section	25.01.2016
PLS-05	Exploded Drawing	25.01.2016
PLS-06	Assembly	25.01.2016
PLS-07	Plastic Reflector	25.01.2016
PLS-08	Roof Connection	25.01.2016

Part inside of Led lighting fixtures, Pelsan xy series indicated in the part list and equipment list, table 1 dated 08.02.2016.

Responsible Person:
Nurgün Terzioğlu
Head of Certification Body

Date of Issue : **22.11.2016**

IEP Ulaştırarak Enerji Petrol Gözetim, Sertifikasyon ve Teknik Hizmetler Organizasyonu Tic. Ltd. Şirketi
57461 Sok. No:3 K:2 Bornova - İZMİR, TÜRKİYE Tel : +90 232 431 17 45 - 46 Fax : +90 232 431 17 30 E-mail: info@iep.com.tr Fr:65
This certificate is granted subject to the general conditions of the IEP Energy Petroleum Institute. This certificate may only be reproduced in its entirety and without any change, schedule included. You can check accuracy of this document by www.iep.com.tr

Page | 2 / 2

ATEX Belgeli Pelsan Exproof armatürler, tehlikeli gaz ve toz maddelerinin bulunduğu, patlama riski olan ortamlarda güvenle kullanılabilir.

Türk Akreditasyon Sertifikası

TÜRKAK TÜRK AKREDİTASYON KURUMU

AKREDİTASYON SERTİFİKASI

Deney Laboratuvarı olarak faaliyet gösteren,

PELSAN AYDINLATMA SANAYİ VE TİCARET A.Ş.
Pelsan Aydınlatma Laboratuvarı
Emek Mah. Nato Yolu Cad. No:280 Sancaktepe
34785 İSTANBUL / TÜRKİYE

TÜRKAK tarafından yapılan denetim sonucunda TS EN ISO/IEC 17025:2012 Standardına göre Ek'te yer alan kapsamlarda akredite edilmiştir.

Akreditasyon No : **AB-0795-T**
Akreditasyon Tarihi : **28 Nisan 2015**

Bu Sertifika, yukarıda açık adı ve adresi yazılı Kuruluşun TS EN ISO/IEC 17025:2012 Standardına, ilgili Yönetmelik ve Tebliğlere uygunluğunu sürdürmesi halinde, **27 Nisan 2019** tarihine kadar geçerlidir.

Dr. H. İbrahim ÇETİN
Genel Sekreter

1701-000 +90 312 410 42 00 - www.turkak.org.tr

Türk Akreditasyon Kurumu tarafından akredite olan laboratuvarımız ile tüm aydınlatma ürünlerini belgelendiriyoruz.

ENEC Belgeleri

bsi.
By Royal Charter

ENEC Certificate

This is to certify that: Pelcan Aydınlatma Sanayi ve Ticaret A.Ş. Cankaya OSB İnces 5 Cad No:12 Dilevazı İzmit Turkey

Holds Certificate Number: ENEC 613253

In respect of: **EN 60598 Luminaires**

(Hereinafter called the certificate holder), having been assessed against the requirements of the CENELEC Agreement on the use of a commonly agreed Mark of Conformity for products complying with European standards (in short the ENEC Agreement), the right and Licence to use the commonly agreed Mark of Conformity for products shown below in respect of the goods particularly described in the Appendix bearing the same number as the certificate.

Goods shall be produced by the certificate holder only at the address given above in accordance with the relevant European Standard as detailed above. The Certificate is granted subject to the Specific Rules for the ENEC Agreement and the BS2 Administration scheme.

For and on behalf of BS2: Gary Fenton, Global Product Certification Director

First Issued: 2014-11-04 Latest Issue: 2017-09-08

Page: 1 of 4

...making excellence a habit.

LED Yol ve Cadde Armatürler

bsi.
By Royal Charter

ENEC Certificate

This is to certify that: Pelcan Aydınlatma Sanayi ve Ticaret A.Ş. Cankaya OSB İnces 5 Cad No:12 Dilevazı İzmit Turkey

Holds Certificate Number: ENEC 664399

In respect of: **EN 60598 Luminaires**

(Hereinafter called the certificate holder), having been assessed against the requirements of the CENELEC Agreement on the use of a commonly agreed Mark of Conformity for products complying with European standards (in short the ENEC Agreement), the right and Licence to use the commonly agreed Mark of Conformity for products shown below in respect of the goods particularly described in the Appendix bearing the same number as the certificate.

Goods shall be produced by the certificate holder only at the address given above in accordance with the relevant European Standard as detailed above. The Certificate is granted subject to the Specific Rules for the ENEC Agreement and the BS2 Administration scheme.

For and on behalf of BS2: Chris Lewis - Certification Director, Product Certification

First Issued: 2017-10-05 Expiry Date: 2017-10-04

Page: 1 of 4

...making excellence a habit.

Sıva Üstü LED Ofis Armatürleri

bsi.
By Royal Charter

ENEC Certificate

This is to certify that: Pelcan Aydınlatma Sanayi ve Ticaret A.Ş. Cankaya OSB İnces 5 Cad No:12 Dilevazı İzmit Turkey

Holds Certificate Number: ENEC 614105

In respect of: **EN 60598-2-5 Floodlights**

(Hereinafter called the certificate holder), having been assessed against the requirements of the CENELEC Agreement on the use of a commonly agreed Mark of Conformity for products complying with European standards (in short the ENEC Agreement), the right and Licence to use the commonly agreed Mark of Conformity for products shown below in respect of the goods particularly described in the Appendix bearing the same number as the certificate.

Goods shall be produced by the certificate holder only at the address given above in accordance with the relevant European Standard as detailed above. The Certificate is granted subject to the Specific Rules for the ENEC Agreement and the BS2 Administration scheme.

For and on behalf of BS2: Gary Fenton, Global Product Certification Director

First Issued: 2014-11-04 Latest Issue: 2017-09-19

Page: 1 of 4

...making excellence a habit.

LED Projektörler

bsi.
By Royal Charter

ENEC Certificate

This is to certify that: Pelcan Aydınlatma Sanayi ve Ticaret Ltd Sti Çekirge Mahallesi Nispetiye Yolu Caddeesi, No 290 Sarıcalıbaşı İstanbul 34710 Turkey

Holds Certificate Number: ENEC 612300

In respect of: **EN 61347-2-9 / EN 60923 Ballasts for discharge lamps**

(Hereinafter called the certificate holder), having been assessed against the requirements of the CENELEC Agreement on the use of a commonly agreed Mark of Conformity for products complying with European standards (in short the ENEC Agreement), the right and Licence to use the commonly agreed Mark of Conformity for products shown below in respect of the goods particularly described in the Appendix bearing the same number as the certificate.

Goods shall be produced by the certificate holder only at the address given above in accordance with the relevant European Standard as detailed above. The Certificate is granted subject to the Specific Rules for the ENEC Agreement and the BS2 Administration scheme.

For and on behalf of BS2: Gary Fenton, Global Product Certification Director

First Issued: 14/10/2014 Latest Issue: 14/06/2015

Page: 1 of 2

...making excellence a habit.

Elektronik Balast

bsi.
By Royal Charter

ENEC Certificate

This is to certify that: Pelcan Aydınlatma Sanayi ve Ticaret A.Ş. Cankaya OSB İnces 5 Cad No:12 Dilevazı İzmit Turkey

Holds Certificate Number: ENEC 664402

In respect of: **EN 60598 Luminaires**

(Hereinafter called the certificate holder), having been assessed against the requirements of the CENELEC Agreement on the use of a commonly agreed Mark of Conformity for products complying with European standards (in short the ENEC Agreement), the right and Licence to use the commonly agreed Mark of Conformity for products shown below in respect of the goods particularly described in the Appendix bearing the same number as the certificate.

Goods shall be produced by the certificate holder only at the address given above in accordance with the relevant European Standard as detailed above. The Certificate is granted subject to the Specific Rules for the ENEC Agreement and the BS2 Administration scheme.

For and on behalf of BS2: Gary Fenton, Global Product Certification Director

First Issued: 2017-09-20 Latest Issue: 2017-09-20

Page: 1 of 6

...making excellence a habit.

Sıva Altı LED Ofis Armatürleri

bsi.
By Royal Charter

ENEC Certificate

This is to certify that: Pelcan Aydınlatma Sanayi ve Ticaret Ltd Sti Çekirge Mahallesi Nispetiye Yolu Caddeesi, No 290 Sarıcalıbaşı İstanbul 34710 Turkey

Holds Certificate Number: ENEC 612302

In respect of: **EN 61347-2-1 / EN 60923 Electronic starting devices**

(Hereinafter called the certificate holder), having been assessed against the requirements of the CENELEC Agreement on the use of a commonly agreed Mark of Conformity for products complying with European standards (in short the ENEC Agreement), the right and Licence to use the commonly agreed Mark of Conformity for products shown below in respect of the goods particularly described in the Appendix bearing the same number as the certificate.

Goods shall be produced by the certificate holder only at the address given above in accordance with the relevant European Standard as detailed above. The Certificate is granted subject to the Specific Rules for the ENEC Agreement and the BS2 Administration scheme.

For and on behalf of BS2: Gary Fenton, Global Product Certification Director

First Issued: 02/12/2014 Latest Issue: 14/06/2015

Page: 1 of 2

...making excellence a habit.

Sodyum-Metal Halide Lambalar



www.pelsan.com.tr

info@pelsan.com.tr • export@pelsan.com.tr

GENEL MERKEZ

İmes Sanayi Sitesi
A Blok 101 Sk. No.38
Y. Dudullu / İstanbul

T: (0850) 460 75 76
F: (0216) 364 60 15

FABRİKA

Çerkeşli OSB İmes
5. Cadde No.12
Dilovası / Kocaeli

T: (0850) 460 75 76
F: (0216) 364 60 15

KARAKÖY MERKEZ

Emekyemez Mah.
Yanikkapı Porsuk Sk.
No.11 Karaköy / İstanbul

T: (0850) 460 75 76
F: (0216) 364 60 15

PERPA BÖLGE OFİSİ

Perpa Ticaret Merkezi
A Blok Kat: 9 No.1178
Okmeydanı / İstanbul

T: (0850) 460 75 76
F: (0216) 364 60 15

Fiyatlara KDV dahil değildir. Pelsan Aydınlatma gerekli koşullarda fiyat ve ürün değiştirme hakkını saklı tutar.



[/PelsanAydinlatma](https://www.facebook.com/PelsanAydinlatma)



[pelsan-aydinlatma](https://www.linkedin.com/company/pelsan-aydinlatma)



[pelsan aydinlatma](https://www.youtube.com/channel/UCpelsanaydinlatma)



[/pelsanaydinlatma](https://www.instagram.com/pelsanaydinlatma)



[/PelsanLight](https://twitter.com/PelsanLight)